



# **VERSANT POWER**

*Versant Power*

*Requirements and Specifications for Electric  
Service Installations*

*Service Installations*

*Revised*

*May 2, 2023*

## Preface

This handbook is effective September 29, 2011 and is a revision of an earlier edition dated August 17, 2001. All earlier editions of, and supplements to, this handbook are superseded and should be destroyed.

If you need additional copies of this handbook, please call or write us at:

Versant Power  
Planning Department  
PO Box 932  
Bangor, Maine 04402-9987

As you read this handbook, you will see the words “Company” and “we” used many times referring to “Versant Power”.

Our corporate headquarters is located at:  
970 Illinois Avenue  
Bangor, Maine 04401  
207-945-5621

### Need More Information?

To contact us for information or assistance, please call our Customer Service Center at 947-2414 or 1-800-499-6600.

### Underground Wires

To contact Dig Safe to locate underground wires before construction  
please call 1-888-DIGSAFE or 1-888-344-7233.

### Power Outage

To report a power outage or other electrical trouble please call us at  
973-2020 or 1-800-440-1111.

### Overhead High-Voltage Line Safety Notice

In Accordance with Maine Law (Title 35A M.R.S.A., Chapter 7-A) a person may not erect, construct, operate, maintain, transport or store any equipment or item within 10 feet of an overhead high-voltage line (except as allowed for in the Law). When it is necessary to carry on any work or activity near an overhead high-voltage line, the person responsible for the work or activity must notify Versant Power by calling 947-2414 or 1-800-499-6600 at least three (3) business days in advance. Versant Power will make the necessary mutually acceptable precautionary safety arrangements.

## Table of Contents

### Section I. Introduction

101	Purpose (8)
102	National Electric Code (8)
103	National Electrical Safety Code (8)
104	Application of Specifications (8)
105	Special Conditions (8)
106	Revisions of Requirements (9)
107	Written Confirmation (9)
108	Customer’s Premises (9)
109	Customer’s Responsibility (9)
110	Access to Premises (9)
111	Customer’s Liability (10)
112	Protective Equipment (10)
113	Rates, Terms and Conditions (10)

### Section II. Definition of Terms

201	Company (10)
202	Customer (10)
203	Dwelling Units (10)
204	Multi-Family Dwelling (10)
205	One-Family Dwelling (11)
206	Voltage Class (11)
207	Service (11)

208	Service Drop
209	Service Lateral
210	Service Entrance Conductors—Overhead
211	Service Entrance Conductors—Underground
212	AWG
213	NEC & NESC
214	Terms and Conditions
215	Service Equipment

### **Section III. Safety and Adequate Wiring**

300	Work Site Safety Policy
301	Safe Use
302	Adequate Wiring
303	Approval and Permit Requirements
304	Voltage Variation
305	Unbalanced Load
306	Emergency or Standby Power

### **Section IV. General Information**

401	Application for Service
402	Temporary Service
403	Inspection
404	Right to Refuse and Disconnect Service
405	Connections
406	Removal of Seals
407	Customer Generation
408	Line and Load Side Conductors

### **Section V. Types and Applications of Electric Service**

501	General
502	Characteristics of Service
503	Applications of Service
504	High Capacity Services

### **Section VI. Overhead Connections from Overhead Secondary Mains**

601	General
602	Single Service Drop
603	Central Distribution Point
604	Point of Attachment of Service Drop
605	Service Drop Clearances
606	Low Buildings
607	Travel Trailers and Other Structures Not Suitable for Direct Service Attachment
608	Manufactured (Prefabricated) Buildings
609	Mobile Homes

### **Section VII. Service Entrance Conductors—Overhead**

701	General
702	Service Head

703 Installation Methods

**Section VIII. Grounding**

801 General  
802 Service Grounding Electrode System  
803 Bonding  
804 Grounding Conductor  
805 Lightning Protection  
806 Surge Protection

**Section IX. Underground Services—General**

901 Customer Costs  
902 Underground Scheduling  
903 Other Underground Facilities  
904 Insurance  
905 Customer Work Responsibility  
906 Soil Conditions  
907 Terminal Poles  
908 Existing Overhead Facilities

**Section X. Privately Owned Underground Services**

1001 General  
1002 Types of Services  
1003 Company Responsibilities  
1004 Customer, Developer, or Builder Responsibilities

**Section XI. Underground Service from a Company Owned Underground Distribution System**

1101 General  
1102 Types of Services  
1103 Company Responsibilities  
1104 Customer, Developer, or Builder Responsibilities

**Section XII. Underground Service—From Existing Underground Mains**

1201 General  
1202 Underground Ducts  
1203 Underground Conductors  
1204 Company Conversion to Underground Distribution System

**Section XIII. Service Disconnecting Means**

1301 General  
1302 Capacity  
1303 Location  
1304 Sequence of Disconnecting Means and Meter Equipment  
1305 Metered and Unmetered Wires  
1306 Type of Disconnecting Means

**Section XIV. Metering Equipment**

1401 General  
1402 Meter Sockets  
1403 Meter Location

1404	Clearance for Metering Equipment
1405	Identification of Meters
1406	Multi-Connection Points
1407	Installation of Meter Devices
1408	Outdoor Meter Installation
1409	Pole Mounted Meters
1410	Prefabricated Meter Centers
1411	Meter Pedestals
1414	Instrument Transformer Cabinets
1412	Multiple Occupancy
1413	Instrument Transformer Metering

## Section XV. Customer Equipment

1501	General
1502	Motors
1503	Power Factor Correction
1504	Arc Welders
1505	Antennas

## Appendix: Exhibits and Drawings

105	Line Voltage Variations
150	Private Line Pole Marking
201	Vertical Clearances of Wires Above Ground, Roadway, Rail or Water Surfaces @ 120' F
202	Minimum Clearances for Service Drops
203.1	Clearances from Buildings and Other Installations Except Bridges
203.2	Clearances from Buildings and Other Installations Except Bridges
203.3	Conductor Categories for Clearances
204	Minimum Clearances for Services 0 – 750 Volts
207	Clearance Between Electric Meters / Equipment and L.P. or Natural Gas Equipment
208	Clearance Between Electric Cables / Equipment and L.P. or Natural Gas Equipment
209	DIGSAFE Safety Zone and Tolerance Zone
2201	Fiberglass Single Phase Padmount Transformer Foundation 25 to 50 KVA
2202	Precast Single-Phase Padmount Transformer Foundation 25 thru 167 KVA
2203	Precast Three-Phase Padmount Transformer Foundation 75 thru 750 KVA
2217	Trench & Conduit Depth for Primary Underground Installations
2218	Multi-Conduit Risers on Versant Power Co Owned Poles
2219	Terminal Pole Except Public Way, 600 Volt or Less
2223	Terminal Pole Except Public Way, Single Phase 15 KV and 35 KV
2225	Terminal Pole Except Public Way, Three-Phase 15 KV and 35 KV
2227.1	Padmount Transformer Locations Near Structures and Roadways
2701	Temporary Service Structure for Use During Building Construction
2702	Rigid Steel Mast 100 - 400A Service to Low Building
2703	Rigid Steel Mast 100 – 400A Service – Multiple Meters to Low Building
2704	Overhead Conduit Service 200 Amps Maximum
2705	Overhead Cable Service 400 Amps Maximum
2706	Overhead Service to Mobile Home, Travel Trailer Customer
2707	Underground Secondary Service on Company Owned Poles
2708	100 – 400 Amp Self-Contained Meter Private Pole Mounted
2709	100 – 200 Amp Outdoor Underground Metering Pedestal
2710	Multi- Metering Pedestal Structure
2711	200 – 400 Amp Outdoor Underground Pedestal Metering
2712	4Class 320 Meter Enclosures

2716	Outdoor Pedestal for Transformer Rated Pad Mount Metering
2718	Current Transformer Rated Service, Outdoor CT Cabinet
2901	Metering Standards for Three-Wire 120/240 Volt Single-Phase With Grounded Neutral (Removed)
2902	Metering Standards for Network Three-Wire 120/208 Volt (Removed)
2903	Metering Standards for Three-Phase Four-Wire Wye (Removed)
2904	Metering Standards for Three-Phase Three-Wire Delta (Removed)

## **REQUIREMENTS AND SPECIFICATIONS FOR ELECTRIC SERVICE INSTALLATIONS**

### **SECTION I**

#### **INTRODUCTION**

##### **101. Purpose**

These specifications are issued for the use of customers, architects, engineers and electrical contractors and are intended to establish standards that will insure safe and satisfactory service. These requirements are not a complete set of rules and cover the common types of installations as supplied by the distribution system of the Versant Power. Installations not specifically addressed herein may require modifications to these requirements.

The customer shall comply with these specifications and the Company will cooperate with the customer and electrical contractor in the application of the specifications. These Standard Requirements are on file with the Maine Public Utilities Commission (MPUC).

##### **102. National Electrical Code**

These specifications are based on and supplementary to the latest edition of the National Electrical Code (NEC) issued by the National Fire Protection Association, and are not intended to conflict with the NEC or municipal and state ordinances. The NEC is hereby made a part of these requirements by reference. Each customer is responsible for having all wiring installed in accordance with the NEC and the requirements of any local inspection authority, and maintained in a safe condition. Versant Power does not accept responsibility for the condition of the customer's wiring and equipment, or damage that may result there from. The local or state electrical inspector is the "authority having jurisdiction" and is, therefore, responsible for interpretation and enforcement of the NEC.

##### **103. National Electrical Safety Code**

The Company, by law (Title 35A M.R.S.A. Section 2305-A) is required to design, construct, operate and maintain its lines and equipment in conformance with the applicable provisions of the most recent edition of the National Electrical Safety Code (NESC). Additionally, any lines that the Company purchases must be in conformance with the edition of the NESC in effect at the time of purchase.

##### **104. Application of Specifications**

These specifications apply to all new installations, all existing installations to which alterations are made, and all other installations that are considered unsafe and hazardous as determined by the Company's inspection.

##### **105. Special Conditions**

When special conditions prevail or when more information is needed, Company representatives will give attention on request. In special installations the Company may alter these requirements, but any departure from the requirements will not be considered as establishing a precedent.

##### **106. Revisions of Requirements**

The contents of this handbook are effective September 29, 2011, and supersede all similar requirements previously issued. Revisions of this information will be made when necessary, and the Company reserves the right to make such revisions. The Company will endeavor to notify those concerned when such changes are made but cannot guarantee to give such notice to all persons who may have received this handbook. It is urged that all architects, engineers, contractors, electricians and other who are interested submit their names and addresses to be included on the mailing list to:

Versant Power  
PO Box 932  
Bangor, Maine 04402-0932

##### **107. Written Confirmation**

The Company will confirm in writing, upon request, all information given regarding service characteristics, applicable rate, service entrances and meter locations. The Company is not responsible for misunderstandings of any nature which may result from information given orally, unless confirmed in writing. In order to avoid delays and possible expensive changes, the above information should always be obtained before purchasing equipment or starting construction.

##### **108. Customer's Premises**

In the absence of negligence or contract, the Company shall not be liable for damage to the person or property of the customer, or any other persons arising from the use of electricity, or the presence of the Company's appliances and equipment on the customer's premises. All property owned by

the Company and located on the customers' premises shall be deemed to be personal property and title thereto shall remain in the Company, and the Company shall have the right at the expiration of service to remove all of its property whether affixed to the realty or not.

#### **109. Customer's Responsibility**

The customer shall be responsible for the safekeeping of the property of the Company on his/her premises, and, in the event of damage to it, shall pay to the Company any cost of inspection and repairs. The customer shall protect the equipment of the Company on his/her premises, and shall not permit any person, except an authorized employee or a person authorized by the Company, to break any seals upon, or do any work on, any meter or other apparatus of the Company located on the customer's premises.

#### **110. Access to Premises**

The Company shall have the right of access to a customer's premises and to all property furnished by the Company installed therein, at all reasonable times during which service is furnished to the customer, and on or after its termination, for the purpose of reading meters, or inspection and repair of Company facilities used in connection with its service, or removing its property, or for any other proper purposes.

#### **111. Customer's Liability**

The customer shall give proper notice to the Company of any substantial increase or decrease proposed in his/her connected load or of any proposed change in characteristics, purpose of use, or location of load. Failure of the customer to give such notice will render the customer liable for any damage to meters, transformers, wires and associated apparatus of the Company resulting from the use of increased or changed load.

#### **112. Protective Equipment**

During emergency conditions, it may be necessary to interrupt service without notice to perform necessary repairs or changes, and to restore service without notice when work is completed. In the process of restoring service, conditions of irregular voltage, single-phasing, or phase reversal may occur. Equipment which might be endangered or which might endanger life or damage property under these conditions, must be provided with suitable automatic protective devices by the customer.

All motors and electronic equipment such as computers and microprocessors, shall be controlled and protected, by the customer, from damage caused by single-phasing or abnormal voltage conditions. Such disturbances are inherent in all supply systems.

The Company cannot be held responsible for damages caused by the customer's failure to provide adequate protection.

#### **113. Rates, Terms and Conditions**

The customer, contractor and those interested are referred to the "Schedule of Rates" and the "Terms and Conditions" as filed with the MPUC, copies of which may be examined at any office of the Company. Customers or contractors shall also make themselves aware of the requirements as set forth in Section IV—General Information. Visit our web site at [WWW.VERSANTPOWER.COM](http://WWW.VERSANTPOWER.COM)

### **SECTION II. DEFINITION OF TERMS**

#### **201. Company**

Versant Power

#### **202. Customer**

A present or prospective user of the Company's electric service.

#### **203. Dwelling Units**

One or more rooms for the use of one or more persons as a housekeeping unit with space for eating, living, sleeping and permanent provisions for cooking and sanitation.

#### **204. Multi-Family Dwelling**

A building containing two (2) or more dwelling units. An area being developed for multiple homes or businesses.

#### **205. One-Family Dwelling**

A building consisting solely of one (1) dwelling unit.

#### **206. Voltage Class**

Primary—2400 volts through 345,000 volts.

Secondary—120 volts through 480 volts.

See Section V Article 502 for standard secondary voltages.

#### **207. Service**

The supply of electricity to a customer, also the conductors and equipment from the Company's lines to the customer's wiring system.

#### **208. Service Drop**

The overhead service conductors from the last pole or other aerial support to and including the splices, if any, connecting to the service entrance conductors at the building or other structure.

#### **209. Service Lateral**

The underground service conductors between the street main, including any risers at a pole or other structure or from transformers and the first point of connection to the service entrance conductors in a terminal box or meter or other enclosure with adequate space, inside or outside the building wall. Where there is no terminal box, meter, or other enclosure with adequate space, the point of connection shall be considered to be the point of entrance of the service conductors into the building.

#### **210. Service Entrance Conductors—Overhead**

The service conductors between the terminals of the service equipment and a point usually outside the building, clear of building walls, where joined by tap or splice to the service drop.

#### **211. Service Entrance Conductors—Underground**

The service conductors between the terminals of the service equipment and the point of connection to the service lateral.

#### **212. AWG**

The American Wire Gauge (AWG) size of wires and applies to copper conductors where used in these requirements. When other material is used, the size shall have a capacity equivalent to copper.

#### **213. NEC & NESC**

The current edition of the National Electrical Code (NEC) as published by the National Fire Protection Association.

The current edition of the National Electric Safety Code (NESC) as published by the Institute and Electrical and Electronics Engineers, Inc.

#### **214. Terms and Conditions**

The Terms and Conditions portion of the Company's Schedule of Rates as filed with and approved by the MPUC.

#### **215. Service Equipment**

The necessary equipment, usually consisting of a circuit breaker or switch and fuses, and their accessories, located near the point of entrance of supply conductors to a building or other structure, or an otherwise defined area, and intended to constitute the main control and means of cutoff of the supply.

### **SECTION III**

#### **SAFETY AND ADEQUATE WIRING**

##### **300 Work Site Safety Policies**

Versant Power requires the use of proper personal protective equipment by all Company employees, contractors and customers that need to be present on a work site. Persons that are not essential for the work being performed will be asked to stay out of the work site. Persons that need to be present or involved in the work will be required to sign on to a risk assessment before the work begins. The risk assessment will address all hazards present at the work site. Whenever possible the hazard should be eliminated (I.E. Open and grounded lines.) If the hazard cannot be removed, the risk assessment will cover what personal protective equipment is needed and the placement of barriers such as shields or insulated cover up. When anyone new arrives on the work site, the work will stop and the new arrival will participate in and sign on to a revised risk assessment.

If there are people on the work site who are not wearing the proper personal protective equipment or participating and following the plan and risk assessment, Versant Power will cease work and leave the site. This may result in additional charges for subsequent trips to complete the work at a later date.

##### **301. Safe Use**

To safeguard the property of the customer and that of the Company, the customer is warned against over fusing either the main fuses or those on branch circuits. Installing overcurrent protection larger than approved by NEC for a specific wire size, or using pennies, or other methods which in any way make protective devices inoperative, CAN CREATE A SERIOUS HAZARD.

##### **302. Adequate Wiring**

The NEC states: "This Code contains basic provisions considered necessary for safety. Compliance therewith and proper maintenance will result in an installation essentially free from hazard, but not necessarily efficient, convenient or adequate for good service or future expansion of electrical use." The Company recommends that engineers, architects, electrical contractors and others make ample provisions for serving present and future loads. This may indicate more than Code Minimums such as a 100 ampere or larger service, larger wire size and more branch circuits. A wiring installation that will serve the future as well as the immediate requirements is a sound investment for the customer.

##### **303. Approval and Permit Requirements**

In municipalities where electrical inspections are required by local authorities, approval must be received before installations will be connected to the Company's distribution system. Such approval can be obtained from the local inspector by the customer or contractor. Where local authorities do not require inspection approval, the wiring contractor shall be required to certify that the installation is in accordance with applicable provisions of the NEC. State law requires a permit for electrical work in other than one-family dwellings, electrical work and equipment incidental to a utility for rendering service, minor electrical repair work, industrials as applicable by state statute, and other installations and alterations subject to municipal



resolution or ordinance. Electrical inspectors will continue to provide inspections for the municipalities they serve, but the state will provide inspections and permits for municipalities without inspectors. A Company employee will inspect the service for safety, clearance, grounding, and other requirements before connecting (see Section IV, Article 403).

### **304. Voltage Variation**

The Company will maintain the voltage delivered to its customers within the limits prescribed in “A” and “B” below. This voltage will be maintained at the Company’s service terminals, such as at the weatherhead for an overhead service drop or at the transformer secondary terminals for a customer owned underground service.

- A. For service rendered principally for residential or commercial purposes the normal voltage variation shall not exceed plus or minus five percent (+ or -5%) from the standard voltage for any period longer than one (1) minute.
- B. For service rendered principally for power purposes the normal voltage variation shall not exceed plus or minus ten percent (+ or -10%) from the standards voltage for any period longer than one (1) minute.

### **305. Unbalanced Load**

The customer shall at all times take and use energy or generate energy in such a manner that the load will be balanced between phases to within nominally 10%.

### **306. Emergency or Standby Power**

The following general requirements apply to customer generating facilities designed to operate isolated from the Company’s electrical system. The Company will provide, upon request, a booklet of recommendations for connecting emergency generators for residential customers.

Versant Power strongly encourages all customers to have a licensed electrician install the equipment necessary to connect emergency generators to their home’s electrical system whether permanently connected or portable. The customer should contact their local electrical inspection authority for final approval.

Non-Parallel Operation—When the customer makes provision for or installs a generator for the purpose of supplying all or just part of the electrical load, the customers wiring shall be so arranged to prevent back-feeding on the Company power lines. This arrangement will prevent interconnection between the Company lines and the customers emergency or standby source of supply.

A positive acting, UL listed double-throw switch or transfer device which is acceptable to the Company and meets all of the following requirements shall be used.

- A. When service is manually transferred, this switch must be so arranged as to open all ungrounded conductors of the normal supply from the Company before any connection is made to the emergency supply.
- B. The double-throw switch or transfer device must be so constructed and connected as to positively prevent any possibility of power from the customer’s emergency source feeding back into the Company’s distribution system.

When it is desired to energize all of the customer’s distribution circuits from the emergency source, the above switch may be connected on the line side of the regular service disconnecting means. The switch should not, however, be connected to the source side of the Company power meter. Where this switch is exposed to the weather, it must be of a rain-tight construction.

Conductors that may be energized by emergency generating equipment shall not be located in the same conduit or raceway as service entrance conductors from the Company’s system.

When the emergency generator is arranged to serve only specific equipment by use of separate circuits that are not connected to the normal wiring system, a main transfer switch will not be required. Also refer to Section 407.

## **SECTION IV**

### **GENERAL INFORMATION**

#### **401. Application for Service**

Now that you have spoken with a Customer Service Representative, a Versant Power Field Representative\* will visit your site to determine the location of our meter and the route required for additional poles or underground wires.

- \* If you haven’t set up your new account yet, you must do so now. Application for new or enlarged electric service shall be made by calling our Customer Service Center at 947-2414 or 1-800-499-6600. To avoid delay in receiving service at the desired time, it is essential that the application be made as far in advance as possible.

When planning the installation, and before material is purchased, the customer is requested to confer with the Company to determine the availability of service and location of service and metering facilities. The following information will be required:

- Number, size and type of service entrance conductors.
- Exact location of premises.
- Date service will be required.
- Size of proposed load in KW and/or HP.
- Load sheet (form 2001) will be required for all 25kw load or 3ph services.
- HP and quantity of any motors.

- Special requirements.
- Temporary or permanent locations should be approved.

Point of attachment of customers service drop, transformer location and poles must be reviewed by the Company before any wires are installed. Poles used to support transformers and foundations supporting pad mounted transformers or other equipment must be accessible from maintained driveways or roads. Exact locations must be approved by the Company prior to construction. All pad mounted transformers and equipment must be protected from traffic by suitable barriers or bollards.

Effective May 12, 2002 MPUC Chapter 395 requires that private lines must be determined safe and reliable. Such determination may be provided by a Registered Professional Engineer, a person designated by the T&D utility or by a person licensed by the Maine Office of Licensing and Professional Registration. Qualified Versant Power employees will provide private line certification at rates found in the Company's Terms and Conditions.

#### **402. Temporary Service**

The service wiring for a temporary installation shall be made in the same manner as for a permanent installation, indoors or outdoors. Any temporary supports must meet with the approval of the Company. A typical temporary service structure is indicated by Appendix Drawing Number 2701. The installation must be properly grounded, as specified in Chapter 2 in accord with the NEC Article 250, and approved by the local inspection authority in areas where such inspection is required. The Company shall always be consulted before work is started to determine location of temporary and permanent service, and metering facilities.

The cost of installing and removing temporary service facilities by the Company may be charged to the customer.

#### **403. Inspection**

The Company inspects the service installation only, including all workmanship, wiring and related equipment from the Company's connection to and including the first customer-owned overcurrent device or devices. The Customer must provide the Company access to the service equipment. Approval shall be given by the local inspection authority where required and the Company requirements must be met before the service will be connected. If it is necessary for the Company's representative to make more than one trip to connect service due to installation not conforming to the Company's requirements, the cost of such extra time may be charged to the customer (see Section III, Article 303).

The Company shall not be responsible for the installation or maintenance of the customer's electrical equipment, nor shall there be any duty or obligation on the part of the Company to inspect the same.

**Municipal Inspections**—Certain communities rely on a municipal inspector to approve your electrical installation. The inspector will notify Versant Power if your service meets their approval. If there is no municipal inspector in your area, regulations require that one of these forms be obtained:

- **Certificate of Electrical Inspection**—This form is approved by your electrician or the state electrical inspector. It is required for all single-family residences. It is not required for manufactured or mobile homes.
- **State Electrical Permit**—New or upgraded commercial facilities, multi-family dwellings (greater than one-family), and all temporary services require the State Electrical Permit. As a general rule, installations with more than one meter will require a State Electrical Permit. This form is signed by your electrician and approved through the State Electrician's Examine Board. A fee payable to the state is required for this permit. The State Electrical Inspectors want to inspect every job prior to connection. Please allow enough time for inspection by State Electrical Inspectors prior to asking for final Company service connection. Versant Power will proceed with the connections once you have given the Company your permit number.

#### **404. Right to Refuse and Disconnect Service**

The Company reserves the right to refuse electric service to a new or existing installation, or to disconnect an existing installation from the Company's lines, should it be determined by inspection that such installation does not conform to the requirements of the Company, or the NEC, or presents a safety hazard to the general public which might injuriously affect the customer's equipment, equipment of the Company, or the Company's service to other customers. Cases of dispute shall be referred to the authority having jurisdiction.

#### **405. Connections**

All connections of customer-owned equipment and material to the Company's facilities must be made by an authorized employee of the Company.

#### **406. Removal of Seals**

In general, Company seals shall be removed only by an authorized employee or a person authorized by the Company. The Company must be notified when the service is to be reenergized. In emergencies, qualified individuals may be given verbal permission to remove seals and de-energize service. A qualified individual must be an electrician with a currently active electrician license issued by the State of Maine. The license must be for a Master Electrician, a Journeyman Electrician or a Limited Electrician with a qualification for "House Wiring" which is restricted to one-family and two-family dwellings including modular and mobile homes. An exception will exist if there is the possibility of damage to property or injury to persons and the qualified individual must de-energize the service so that damage to property or injury will be avoided. Failure to contract Versant Power prior to cutting a meter seal may lead to a charge to the customer or electrician.

#### **407. Customer Emergency Generation**

Versant Power strongly encourages all customers to have a properly licensed electrician install the equipment necessary to connect emergency generators to their home's electrical system. The customer should contact their local electrical inspection authority for final approval.

A positive acting double-throw switch or transfer device shall be used, so constructed and connected as to positively prevent any possibility of power from the emergency source feeding back into the Company lines. Specific requirements and specifications for various types and sizes of customer facilities shall be obtained from the electrical contractor.

The Company will provide, upon request, a booklet of recommendations for connecting emergency generators for residential customers. All installations must meet National Electrical Code. The Company recommends that following the installation of emergency generating equipment, the customer contact their local electrical inspection authority for final approval. Also refer to Section III Article 306.

**408 Line and Load Side Conductors**

Line and Load conductors shall not be permitted within the same conduit, cable or raceway. Metered and unmetered conductors shall not be permitted within the same conduit, cable or raceway.

**SECTION V. TYPES AND APPLICATIONS OF ELECTRIC SERVICE**

**501. General**

To avoid misunderstandings, delays and unnecessary expense, the customer shall always inquire of the Company as to the characteristics of service available before proceeding with the purchasing, installation, or wiring of equipment. This is very important as all classes of service are not available in the entire area served by the Company. The Company will supply only one service to the building as a general rule.

**502. Characteristics of Service**

Service in the territory served by the Company is supplied at 60 Hertz, single or three-phase alternating current at secondary voltages listed below. Primary voltages are available for special installations. Three-phase service is not always available, and may require additional customer costs.

**Versant Power Approved Voltage Class—60 Hertz**

Number of Phases	Number of Wires	Nominal Voltage
1	3	120/240
3	4	120/208
3	4	277/480

Three-wire (network) 120/208 volt service is available with approval from the Company prior to installation.

600 volt services are becoming increasingly difficult to support. Equipment is no longer available at this voltage. Versant Power will not accommodate any increase in load or capacity and cannot guarantee continued service at this voltage. Customers are encouraged to make arrangements to take service at a Versant Power approved voltage (see above). Customer services operating in the 600 volt class will not be reconnected if service is discontinued.

Service voltages of 240 volt three phase three wire delta and 480 volt three phase three wire delta are no longer standard voltages. The Company will not supply new services at these voltages. Increased loads on existing services operating at 240 volt three phase three wire delta and 480 volt three phase three wire delta will require approval by Versant Power Engineering.

Note: Since the Company does not use two-wire metering, service installations shall consist of at least three (3) service entrance conductors as specified in Section VII, Article 701 of this booklet. Any customer or contractor seeking exception to this policy shall make a request to the Meter Tech Department prior to any installation. The Company reserves the right to refuse connection of installations not in compliance with this policy.

**503. Applications of Service**

Applications of each class of voltage are as follows:

- 1. Single-phase three-wire 120/240 volt service.** This type of service will be supplied to residential, commercial and industrial customers for lighting, heating, cooking and small power loads. See paragraph 1502 for motor limitations on single phase services.

Wherever the total connected load exceeds 50 KVA, the Company may require the customer to arrange his wiring for three-phase service.

- 2. Three-phase, four-wire 120/208 volt service.** This type of service will be supplied for large lighting, heating, cooking and power loads or a combination of these loads, when size of load warrants. Lighting and other loads shall be balanced between respective phases as closely as possible. Service taken at this voltage must have a main disconnect no greater than 600 amps when served from pole-mounted transformers. Any disconnect greater than 600 amps will be served by a pad-mounted transformer.

- 3. Three-phase, four-wire 277/480 volt service.** This type of service will be supplied for general service or power installations having demands of not less than 50KVA unless special circumstances so warrant. Service taken at this voltage must have a main disconnect no greater than 300 amps when served from pole-mounted transformers. Any disconnect greater than 300 amps will be served by a pad-mounted transformer.

- 4. Service at primary voltage** is available through negotiation with the Company. The Company shall always be consulted regarding the class of voltage available. Service voltage higher than 480 volts available only by negotiation with the Company. The size and type of a customers load must warrant such an installation.

**504. High Capacity Services**

- 1. Transformer Installations.** Where high capacity services are required or where it is not feasible to use pole-mounted transformers. In the case of the outdoor installation, the customer should contact a Company representative to discuss other options before proceeding.

Before installing transformers adjacent to or within a building, it is the customer’s responsibility to obtain approval from the insurance underwriters for the location selected.

- 2. Multiple Service Conductors.** The number of parallel conductors per phase which may be connected to any overhead service drop shall not exceed two (2) in number, or which may be connected to the terminals of any transformer including pad-mounts shall not exceed four (4) in

number. In cases where more than four conductors per phase are required, or where more than one service is involved, the customer may be required to install a terminal box or other facilities to accommodate the multiple conductors, subject to prior Company approval.

**3. Secondary Conduit Risers and Cable Size.** No more than two secondary cable conduit risers will be permitted on a single pole. The maximum cable size will be 500 kcmil.

## SECTION VI

### OVERHEAD CONNECTIONS FROM OVERHEAD SECONDARY DISTRIBUTION

#### 601. General

The customer will be responsible for providing and installing the point of attachment. The attachment will be either a “J” hook or an eye bolt. All wiring and related equipment, except meters, instrument transformers, test switches, and control cable (see Section XIV Article 1401), on the customer’s side of the point of attachment of the service drop to a building shall be furnished, installed and maintained by the customer. This material includes the service head, service entrance conductors with three feet of slack for connection to the service drop, meter mounting equipment, conduits, service disconnecting means and ground connections. The service drop will be furnished, installed, and maintained by the Company. In general, wherever it is necessary to extend the service drop for more than 150 feet from the established road right-of-way limits, the customer shall furnish, own and maintain the suitable intermediate pole(s) and pay the cost of that part of the service drop which exceeds 150 feet from the road right-of-way limits (see Drawing 204).

#### 602. Single Service Drop

Only one service drop connected to the same overhead mains will be attached to any one building, and only one set of service entrance conductors shall be connected to each service drop except in cases specifically permitted by the NEC or where specific permission has been obtained from the authority responsible for the enforcement of the NEC. The drop may consist of parallel service cables for capacity. Overhead services may be provided up to and including 600 ampere single switch or 1,000 ampere total switch frame capacity unless limited by construction problems. Where greater capacity is required, other types of construction such as underground service must be used. Refer to Section IX.

#### 603. Central Distribution Point

On farms and other premises where several buildings are under one ownership, it may be desirable for the customer to take service for the buildings directly from one customer owned pole, if otherwise permitted under the Company’s Terms and Conditions. The Company will permit metering on private poles. It will be the responsibility of the customer to furnish and install service drops and other service equipment for each building served that is beyond the meter. In no event will any customer owned services pass from the central distribution point back onto Company poles. For installations of this type, a weatherproof main disconnect switch be installed on the pole. All installations of this type shall be referred to the Company for approval before any wiring is started.

#### 604. Point of Attachment of Service Drop

The point of attachment of a service drop to a structure shall be designated by a representative of the Company before service wiring is started.

Customers having service wiring installed without first obtaining location approval for the point of attachment do so at the risk of having to relocate same.

#### 605. Service Drop Clearances

Location	Minimum Clearances
Sidewalks and spaces accessible to pedestrians only	12 feet
Over residential driveways	16 feet
Over railroad tracks	24 feet
Public streets, roads, alleys and commercial or industrial driveways	18 feet

The above clearances are the minimum required at 120 degrees final sag or 32 degrees and one half (1/2) inch ice, whichever produces the greatest sag. (NESC requirements.)

#### 606. Low Buildings

In order to obtain minimum clearances for various types of low buildings, it may be necessary for the customer to install a pole or a Company approved extension mast (see NEC Article 230-24 or Drawings 202 and 2702). If minimum clearances are not obtained, the service will not be connected.

#### 607. Travel Trailers and Other Structures Not Suitable for Direct Service Attachment

An approved rain-tight service disconnecting means rated at not less than 60 amperes and with appropriate overcurrent protection shall be installed in accordance with National Electrical Code Article 373-2, at the meter location (refer to Illustration No. 6 or No. 28 in Section XII). For recreational vehicles, the disconnecting means shall generally be located near the point of entrance of supply conductors in compliance with the NEC, Article 551.

#### 608. Manufactured (Prefabricated) Buildings

Manufactured (prefabricated) buildings, including modular homes, may have the service drop and meter mounted on the structure if of sufficiently sound construction and set on a permanent foundation. The service entrance conductors and equipment shall be in accordance with standard services in this handbook and the NEC, Article 230 and Article 545.

## **609. Mobile Homes**

### **A. Service Equipment Separate from the Structure:**

An approved rain-tight service disconnecting means rated at not less than 100 amperes and with appropriate overcurrent protection shall be installed in accordance with NEC Articles 373-2 and 550 at the meter location (refer to Illustration No. 6 or No. 28 in Section XII). Company approved pre-wire combination meter and service equipment may be used.

If the meter is located more than 30 feet from the mobile home, then the disconnecting device with appropriate overcurrent protection shall be located within 30 feet of the mobile home in compliance with the NEC, Article 55-23. This disconnecting means shall then be considered the service entrance equipment and the disconnect at the meter location may be omitted. However, the service cable from the meter location to the service entrance equipment must comply with all Company standards for an underground service cable installation.

### **B. Service Equipment installed on the Structure:**

A permanently-sited mobile home manufactured under a HUD seal, with undercarriage removed, and connected to water and sewer, may have the service equipment installed directly on the structure provided that it is installed in a manner acceptable to the “authority having jurisdiction” (local or state electrical inspector) as stated in NEC Article 550-23 (a), Exception No. 2.

The electrical inspector will generally require that the installation comply with the mobile home manufacturer’s instructions on proper attachment to the structure.

## **SECTION VII. SERVICE ENTRANCE CONDUCTORS—OVERHEAD**

### **701. General**

The service entrance conductors are the conductors between the terminals of the service equipment and the connection to the Company’s overhead service drop.

All service installations shall consist of at least three (3) conductors, of a type approved for this purpose by the NEC, and with a capacity sufficient to carry the load consistent with the NEC, with larger sizes recommended for future load growth.

The ungrounded conductors shall not be smaller than No. 6 AWG copper or equivalent, and the minimum neutral size per NEC Requirements.

For special limited applications, smaller conductor sizes may be used in compliance with NEC, and approved by the Company.

### **702. Service Head**

An approved service head shall be installed above and within approximately 12 inches of the service drop point of attachment. At least three (3) feet of the service entrance conductors shall extend beyond the service head, to provide suitable drip loops for preventing entrance of moisture.

### **703. Installation Methods**

Service raceway and service entrance conductors shall be continuous without taps, breaks, splices, junction or outlet boxes from service head to service disconnecting means, except at meter. Raceway or cable shall be exposed for its entire length except where it enters and passes through the building wall and except where a service mast passes through the roof overhang.

The raceway or cable shall be securely attached to building or structure and all connectors, screws or other metal devices shall be rust-proof.

It is recommended that when the exterior construction of the building consists of rough stone, brick, stucco, or metal siding, all service entrance conductors shall be installed in rigid or intermediate metal conduit, steel electrical tubing, or rigid non-metallic conduit recognized for use above ground as permitted by Article 347 of the NEC. Raceway or cable must not be attached to chimneys or roofs.

Cable or raceway shall always be located so that entrance through building is at least 12 inches above ground level and so that proper clearance will be provided from rain spouts, fire escapes, telephone wires, windows and blinds.

The service entrance equipment shall be located as near as possible to the point of entrance of the conductors.

All services shall be installed in accordance with the NEC (see Appendix Drawings).

## **SECTION VIII. GROUNDING**

### **801. General**

A permanent and effective ground must always be provided for service equipment, in accord with the requirements of NEC Article 250—Grounding. The neutral conductor of the service shall always be grounded and the grounding connection shall be made in the outdoor meter socket and/or in the service cabinet. No conductor of a three-phase, three-wire service shall be grounded at any point in the wiring installation. All grounding shall be complete before the Company will make the service connection to its lines.

### **802. Service Grounding Electrode System**

In accordance with National Electrical Code Section 250-H, the service grounding electrode system shall consist of the following:

Two ground rods, driven to their full depth and separated by six feet must be installed. The rods must be connected together. They must be at least eight feet long, not smaller than 5/8 inch diameter if of galvanized steel, 1/2 inch diameter if of approved copper clad steel.

### **803. Bonding**

All grounding electrodes used on the premises shall be bonded together, and bonded to any interior metal piping system, heating systems, meter enclosures, troughs, metallic pole risers, conduits, cable armor and cabinets, or other extensive metal systems.

Bonding is effective as a means to prevent or mitigate problems due to the phenomenon commonly called stray voltage. The Company recommends that provisions be made to bond any steel reinforcing mesh or rod to the electrical grounding system whenever any concrete slabs are poured. This is particularly important for dairy barns and houses constructed on concrete slab foundations. Refer to NEC Article 547-8 for information regarding equipotential planes in agricultural buildings.

Whenever work is in progress on any premises, contractors are urged to inspect the condition of all grounds and bonds, and inform the owner accordingly. The connection to a metal underground water system shall be on the street side of the water meter, if practical, otherwise bonds shall be placed around all parts which may be disconnected, between the point of attachment and the street side of the water meter.

### **804. Grounding Conductor**

The grounding conductor shall always be rigidly supported, protected from mechanical damage and be securely attached to the grounding electrode with a cast metal clamp or other device or method as approved by the NEC. The size of the conductor must also meet the requirements of the NEC Article 250-92A and in no case be smaller than No. 6 AWG Copper. If a ground rod is placed away from a building foundation, the grounding electrode conductor shall be protected by burying beneath the surface of the ground.

### **805. Lightning Protection**

When electric service is installed in a building that is equipped with lightning rods (or vice versa) and both systems are grounded by driven electrodes, the NEC requires that a separation of at least six feet be maintained between electrodes wherever practical. The grounding electrode systems should be bonded together. The ground connections from a television antenna for the purpose of lightning protection should be treated the same as a lightning rod ground.

### **806. Surge Protection**

All [whole house](#) power surge devices must be connected on the load side of the meter and be installed by a licensed electrician.

## **SECTION IX**

### **UNDERGROUND SERVICES—GENERAL**

#### **901. Customer Costs**

Arrangements for the payment of any costs which are to be the responsibility of the customer in connection with the installation of underground service, shall be made in advance of construction of the system. Such cost can include but are not limited to the cost of underground cable, underground cable terminations, underground cable load break elbows, underground cable feed through devices, fusing / switch cabinets and the cost difference between pad mount transformers and pole mount transformers.

#### **902. Underground Scheduling**

Construction of underground systems shall not normally take place during winter or early spring. Installation of underground facilities involving Company owned equipment or facilities which will subsequently be owned by the Company shall not take place during such periods without the written consent of the Company. Any additional costs incurred as a result of installation of underground facilities during such periods shall be the responsibility of the customer.

#### **903. Other Underground Facilities**

Water and sewer facilities and other construction normally installed below the electrical facilities shall be completed before the electrical facilities are installed. The Company will require an easement for any Company owned underground facility on private property. The customer will provide an as built survey by a registered land surveyor that will be attached and filed with the easement at the registry of deeds.

#### **904. Insurance**

Customers desiring the installation of underground facilities shall consult with their insurance carrier concerning the location of such facilities, proper clearances, the presence of Company-owned equipment, and other matters.

#### **905. Customer Work Responsibility**

Work for which the customer is responsible involving Company-owned facilities or facilities which will subsequently be owned by the Company, shall be completed in accordance with the standards and specifications of the Company. Notification of work being done shall be required and trench inspections prior to back filling may be necessary.

#### **906. Soil Conditions**

Soil and terrain conditions must be suitable for an underground system, as determined by the Company's Engineering Department. Where ledge excavation is necessary, a reduction of cover may be allowed where supplemental protection is provided as permitted by the NEC (see NEC Articles 300-5(a) and 710-3(b), and NESC Section 35). All underground facilities will be installed with proper drainage. Conduit and foundation systems that do not properly drain will not be connected.

## **907. Terminal Poles**

Company-owned terminal poles for underground service shall be 40 feet minimum length. No underground services will be installed on distribution/transmission poles without permission from the Company (refer to Drawing 2707). Whenever possible, underground services and line extensions will originate from new poles located outside the public way.

## **908. Existing Overhead Facilities**

If primary underground facilities are service is requested to replace existing overhead company facilities, the customer must pay the full replacement cost. All new company owned undergrounds replacing existing overhead lines will have redundant cable runs for reliability,

## **909. Underground Service and Primary Cable Riser Construction**

When installing risers on de-energized structures, the electrician will have all of the cable and conduit riser construction complete and attached to the. If the electrician is not able to complete the work, then Versant Power will assist if resources are available. The electrician will be charged for the cost of the work.

When installing 2.5" (two and one half inch) risers on energized structures, the conduit, cables and weather head shall be assembled in one piece on the ground from the top of the sweep at the foot of the pole to the weather head. Versant Power will raise this assembled riser and mount it on the pole. The electrician will provide all materials needed for a complete installation.

On Energized structures with conduit risers in excess of 2.5" (two and one half inch) the electrician will install no more than one ten foot section of conduit on the pole. Versant Power will then assist with the installation of the remaining conduit, support brackets and hardware. Once the conduit system is complete, Versant Power will assist with the installation of the conductors. The electrician will provide all materials needed for a complete installation.

## **SECTION X**

### **FROM A PRIVATELY OWNED UNDERGROUND SERVICE**

#### **1001. General**

1. Versant Power will allow private underground service to a customer subject to the customer providing and installing his material and equipment compatible with and approved by the Company. The service will be a customer-owned facility and subject to the excess cost and private overhead line provisions stated in these standards.
2. Underground services should be installed in complete accord with Company specifications to provide for possible future acceptance by the Company in case of service expansion to include other customers.
3. A plan of the underground facility should be provided for the project file.

#### **1002. Types of Services**

1. Residential underground primary or secondary service.
2. Commercial, industrial, and government underground primary and/or secondary service.

#### **1003. Company Responsibilities**

1. Furnish, install, own and maintain padmount transformer (as required).
2. Furnish, install, own and maintain lightning arresters, fused cutouts, terminations and load break elbows, on Company-owned facilities.
3. Install customer supplied conduit, conductors, bushings and conduit clips on Company-owned poles where energized power line are present.

#### **1004. Customer, Developer, or Builder Responsibilities**

1. Provide all excavation, ductwork, and backfill involving Company facilities in accord with Company specifications.
2. Furnish, install, own and maintain primary and/or secondary cable, which must be compatible with Company equipment.
3. Furnish and install duct system, as required, under all public ways.
4. Furnish terminal pole riser conduit(s) including necessary fittings. The Company will assist with the conduit installation on Company pole if energized power lines are present. (Refer to Drawing 2707).
5. Maintain safe operating conditions and keep building, bushes, and trees clear of Company facilities. Compliance of this rule must meet with Company approval.
6. Fuse cabinets and transformers must be located so that they are readily accessible by a Company truck. Access to this equipment will be from a maintained driveway, road or parking area. Pad mounted equipment will be protected from traffic and not exposed to damage from snowplowing. Pad-mount transformers and fuse cabinets shall not be located more than 20 feet from truck access or a paved way. (Refer to Drawing 2227.1).
7. The conduit system and transformer foundation must be provided with adequate subsurface drainage, and be graded for proper surface water run off. The foundation must meet Company standards. Refer to Standards Drawings for drainage details.
8. Transformer barriers or bollards must be provided to Company specifications, where danger of traffic or snowplow damage or snowplow exposure exists. . (Refer to Drawing 2227.1).

9. Pay all cost quoted by the Company including excess cost before construction.
10. Provide a Legal Description locating all Company facilities on private property.
11. Sign service agreements, service contract, and easements provided by the Company.
12. Check with local, county, state, and federal governments for necessary permits to locate underground facilities on or across public ways.

## **SECTION XI**

### **UNDERGROUND SERVICE— COMPANY-OWNED UNDERGROUND DISTRIBUTION SYSTEM**

#### **1101. General**

Versant Power will own an underground distribution system when requested by a customer, builder or developer. The Underground Distribution System will become a Company-owned system upon satisfactory completion as outlined in these standards, and approved by the Company's Engineering Department. The Underground Distribution Network will be subject to the excess cost provisions, all other applicable provisions under Section IX of these standards, and all provisions outlined within Section XI of these standards.

#### **1102. Types of Services**

1. Residential underground primary service.
2. Commercial, industrial and governmental underground primary service.
3. Residential, industrial and commercial underground primary distribution network, residential subdivision, industrial park, etc.

#### **1103. Company Responsibilities**

1. Furnish, install, own and maintain pad-mount transformer(s).
2. Furnish, install, connect, own and maintain primary power cable.
3. Acquire appropriate permits from local, county, state and federal governments.

#### **1104. Customer, Developer or Builder Responsibilities**

1. Provide all excavation, ductwork and backfill involving Company facilities in accord with Company specifications.
2. A pull wire must be provided by the customer in all ducts to facilitate the installation of cable.
3. Furnish to the Company four (4) complete copies of the site plan for the development as approved by the municipality. Such plans should show the grading, layout and dimensions of lots, sidewalks and curbs, the location of water systems, storm, sanitary sewer systems, and other underground structures.
4. Furnish to the Company four (4) complete copies of the electrical plans for the development. Such plans should show the electrical riser diagram, electrical load data, estimated electrical demand and meter arrangements.
5. Provide a legal description locating all Company facilities on private property.
6. Execute service agreements, service contract, and easements provided by the Company.
7. Furnish and install transformer foundation per standards Drawings 2201 through 2203.
8. Fuse cabinets and transformers must be located so that they are readily accessible by a Company truck. Access to this equipment will be from a maintained driveway, road or parking area. Pad mounted equipment will be protected from traffic and not exposed to damage from snowplowing. Pad-mount transformers and fuse cabinets shall not be located more than 20 feet from truck access or a paved way. (Refer to Drawing 2227.1).
9. Provide adequate subsurface and drainage for transformer foundations and conduit systems.
10. Transformer barriers must be provided to Company specification, where danger of traffic damage exists.
11. Maintain safe operating conditions and keep buildings, bushes and trees clear of Company facilities.
12. Upon completion of the Project, provide the Company with a reproducible "as built" site plan no larger than 8 1/2" x 14" Mylar showing the location of all underground facilities.
13. Pay all cost quoted by Company including excess cost before construction.

## **SECTION XII**

### **UNDERGROUND SERVICE—FROM EXISTING UNDERGROUND DISTRIBUTION**

#### **1201. General**

The Company must be consulted before any work of this type is started as requirements will be given for each individual installation.

#### **1202. Underground Ducts**

In areas where the distribution system is underground, the Company will furnish, install and maintain the necessary duct line within the limits of the public way, and the customer will be required to furnish, install and maintain any extension of the duct line beyond the street line to the service entrance equipment in his building. The customer will be responsible for the cost of the work within the street line and the cost of the extension.



### **1203. Underground Conductors**

The Company will furnish, install the necessary conductors from the distribution system to the service entrance equipment. The customer will be responsible for the cost of the conductors.

### **1204. Company Conversion to Underground Distribution System**

In cases where the Company converts from an overhead to an underground distribution system, the customer will be required to bear the cost of rearranging his service entrance to accommodate the underground connection.

## **SECTION XIII**

### **SERVICE DISCONNECTING MEANS**

#### **1301. General**

Each set of service entrance conductors shall be provided with an approved type of disconnect for disconnecting all ungrounded conductors from the source of supply. In multiple occupancy buildings, where required by the NEC or as specified by local ordinances, a main service disconnecting means shall also be installed so as to completely disconnect all ungrounded interior wiring at one point.

#### **1302. Capacity**

The service disconnecting means shall be of a type and size approved for such use by the NEC, with a minimum capacity of 100 amperes, three-wire, but not less than the load to be carried as determined in accordance with NEC Article 220 (see Section VI, Article 607).

For a one-family dwelling, the service disconnecting means shall have a minimum rating of 100 amperes, three-wire, where the initial computed load is 10KW or more.

The minimum size service disconnecting means for a temporary service shall be 20 amperes. (Revised November 2, 1987.)

#### **1303. Location**

The disconnecting means shall be located at a readily accessible point, as near as possible to the point of entrance of the service conductors into the building. It is recommended that the service disconnecting means should not be located in bathrooms, or other normally locked areas.

#### **1304. Sequence of Disconnecting Means and Meter Equipment**

The location of the service disconnecting means shall be on the load side of the metering equipment (meter-switch-fuse sequence).

**Exception 1**—In multiple meter locations where the NEC requires a main disconnect, the sequence shall be main disconnect-meter-switch-fuse.

**Exception 2**—The Company may allow a switch-fuse-meter sequence in switchgear. Prior Company approval is required.

When NFPA regulations require fire alarm systems to be tapped into the line side of the main disconnect, then the metering shall be on the line side of all disconnecting means. Meter-fire alarm-switch-fuse sequence.

#### **1305. Metered and Unmetered Wires**

All unmetered wires, except those used as service entrance conductors in cable, shall be run in steel or aluminum conduit, steel electrical metallic tubing, suitable rigid non-metallic conduit or sealable standardized metal troughs as permitted by the NEC. Metered and unmetered wires shall not be run in the same conduit, raceway or gutter.

#### **1306. Type of Disconnecting Means**

The minimum size and type of service disconnecting means is a 100 ampere switch or circuit breaker, which shall be approved for such use by NEC and meet the following requirements:

1. Externally and manually operable, and shall indicate whether it is in the open or closed position.
2. Solid neutral type with no overcurrent device in the grounded service conductor.
3. Approved for service equipment use, and for the prevailing conditions, by Underwriter's Laboratories, Inc., or other accepted testing laboratory.

The Company reserves the right to specify, and seal, the type of disconnecting means that must be used for any particular installation, as a general safety measure and protection against tampering by unauthorized persons.

For small or special installations which supply limited loads, the disconnecting means may be rated less than 100 amperes in compliance with NEC and approved by the Company.

## **SECTION XIV. METERING EQUIPMENT**

#### **1401. General**

The customer shall furnish Company-approved meter mounting devices. All such enclosures must be sealable with padlock type seals and such seals shall be removed only by an authorized employee or a person authorized by the Company. All meter sockets, meter troughs, and meter modules shall have the Underwriter's Laboratory Label, or other accepted laboratory label. The Company will furnish and install all meters.

When required, current transformers, potential transformers, test switches, and control cable will be furnished by the Company for installation by the contractor in an enclosure furnished by the Company or in the customer's service equipment. Secondary electrical connections to the meter will be done by the Company. All metallic equipment used for metering purposes shall be properly grounded as required by Article 250 of the NEC.

A meter socket (enclosure) shall be permanently and solidly mounted before the meter will be installed. All outside meter enclosures must be secured by screws, #12 minimum, which are stainless steel or zinc or cadmium coated (no washers allowed). Whenever a meter enclosure is mounted on siding (no backboard) use of screws that accommodate a Phillips and/or slotted style screwdriver is requested. Self contained meter sockets attached to a building shall not be secured such that the cables will prevent subsequent access to the mounting screws. This requirement is to allow for future "floating" of the meter socket.

#### **1402. Meter Sockets**

Socket meters will be standard for all single-phase and three-phase installations where the load does not exceed 200 amperes and 400 amp 120/240 single-phase and 120/208 three-phase. All poly-phase and 400 amp single-phase meter sockets must have a single handle-operated manual bypass which locks the meter blades in the socket jaws. The manual bypass operating mechanism must be visible when the meter is installed. It must not be possible to override the bypass by replacing the cover or sealing ring when the operating mechanism handle is in the bypassed position. Manual bypass operating mechanisms will be allowed on 200 amp single-phase meter sockets when there is a disconnect within sight of the meter socket.

None of the following features are allowed, and shall cause rejection of the meter mounting device and refusal to connect service until an acceptable device is installed.

- 1. Automatic by-passes.** Automatic by-passes are not permitted.
- 2. Horn-type by-passes.** Horn-type by-passes are not permitted.
- 3. Aluminum sealing rings.** Aluminum sealing rings are not permitted as a substitute for stainless steel sealing rings.

A special metering socket, which shall accept a fifth terminal at the 9 o'clock position, is required for a network service consisting of any two-phase conductors and a ground conductor obtained from a three-phase, four-wire system.

#### **1403. Meter Location**

The location of all metering equipment shall be designated by a Company representative, and selected with regard to accessibility for reading and maintenance. Customers having wiring installed for metering without first obtaining Company approval do so at the risk of having to relocate same. Meters will always be located outdoors. Indoor meter installations will be allowed only when special advance approval has been obtained from the Company's representative.

#### **1404. Clearance for Metering Equipment**

Not less than three feet of clear, unobstructed space shall be provided and maintained under and in front of all metering equipment. In the case of unguarded moving machinery, changes in floor level, etc., a distance of four feet shall be provided in front of all meters. A clearance of at least twelve inches shall be provided between the nearest obstruction above and on each side of any single meter or group of meters. Clearance measurements shall be made from the sides, top or bottom of the meter enclosure.

The Company shall be consulted in all cases where meter mounting space is limited. When meters are mounted in a group, special layouts shall be obtained from the Company before proceeding with equipment installation. Sufficient clearance shall be provided in choosing the location of all metering equipment so that the doors of all cabinets can be completely opened.

#### **1405. Identification of Meters**

Wherever there is more than one meter installed on any one premises, the area served by each meter, such as room or apartment number, floor or other area, shall be neatly and plainly marked on the service entrance equipment and, if the meter is mounted outdoors, on the top of the meter enclosure—**not on the cover**—with paint. Where meters may be stacked, the identification must be made on a permanent part of the equipment as near as possible to each meter. Do not put identification on the covers, as covers can be removed and interchanged.

#### **1406. Multi-Connection Points**

Single terminals of meters, or meter connection blocks, shall be used as a connection point for one conductor only. Where multiple conductors are used, terminal lugs or copper bus sections suitable for attaching to the source shall be furnished and installed by the contractor (see Drawing 2704a).

#### **1407. Installation of Meter Devices**

All meter sockets and mounting devices shall be rigidly secured with screws, to provide a clear space suitable for mounting the meter in a level and perpendicular position with meter rotor shafts plumb. Meter heights must not be over (5) five feet or less than (4) four feet from ground or floor level to the top of the meter. Exceptions to meter heights will be allowed only where special conditions exist (see Section XIV Article 1410).

#### **1408. Outdoor Meter Installation**

Socket type metering shall be used on all new self-contained outdoor meter installations, all reestablishments of inactive or abandoned services, all services to which alterations are being made, and those services that are considered unsafe by the Company's representative. The electrical contractor will install the meter socket furnished by the customer, which must be of a type approved by the Company's Meter Department. Approved fittings and gaskets must be used for all connections.

Without the approval of the Company, outdoor meter installations shall not be enclosed or obstructed in any manner.

#### **1409. Pole Mounted Meters**

Meters generally will not be allowed on Company poles. Meters installed on customer's poles should be done only after consulting with the Company's representative. Where more than one meter is or may be required in the future on this same pole, other arrangements may be necessary (see Drawing 2706).

#### **1410. Prefabricated Meter Centers**

Prefabricated meter centers, which are UL approved for the application and meet the following requirements, may be used for indoor or outdoor multiple meter installations:

1. The maximum number of meters allowed in vertical arrangement shall be four (4).
2. Minimum distance from floor level to top of bottom meter is 18 inches.
3. Maximum distance from floor level to top of top meter is 66 inches.

#### **1411. Meter Pedestals**

Meter pedestals used with underground services must be approved in advance by the Company. The meter pedestal must be installed so that the top of the meter will not be more than five feet or less than four feet above the finished grade or ground line (see Drawing 2715).

#### **1412. Multiple Occupancy**

The location of all metering equipment shall be designated by a Company representative, and selected with regard to accessibility for reading and maintenance. Customers having wiring installed for metering without first obtaining Company approval do so at the risk of having to relocate same. Meters will always be located outdoors. Indoor meter installations will be allowed only when special advance approval has been obtained from the Company's representative.

#### **1413. Instrument Transformer Metering**

Installations rated in excess of 200 amperes or 400 amp 120/240 or 120/208 three-phase, shall be arranged for instrument transformer metering. In such cases, the Company will furnish the necessary instrument transformers and meter connection box of either the indoor or outdoor type with test switch. The electrical contractor will install the cabinets, meter box, and 1½" steel or IMC conduit from each set of remote current transformers to each meter box for the secondary metering conductors. Conduit should be no more than 40 feet in length. Conduits underground should be 1 1/2" rigid or IMC (see Drawings 2714, 2715 and 2718.)

When the service equipment consists of prefabricated metal-enclosed cubicles or switchboards designed for built-in instrument transformers, the customer shall obtain specifications from the Company for the transformers which the Company will furnish. The cubicles or switchboard shall then be manufactured to accommodate the specified instrument transformers.

On installations where the neutral conductor does not pass through the transformer compartment, an insulated neutral conductor, not smaller than the service grounding conductor, shall be brought into and connected to an insulated terminal in the transformer compartments. Metered and un-metered busses or conductors shall be separated by barriers. The Company shall always be consulted before this type of metering transformer arrangement is specified.

#### **1414. INSTRUMENT TRANSFORMER CABINETS**

For installations where the service voltage does not exceed 480 volts, cabinets for instrument transformer ( C.T.s ) shall be furnished by the customer and be constructed and installed so as to meet the requirements of NEC Article 312. Cabinet size will be as specified by Versant Power (the Company)

All cabinets shall be constructed so the cover can be readily opened. The cover shall be attached with hinges. The cabinet must be mounted so that the cover does not interfere with installation or maintenance work. All cabinets shall be weatherproof or rain tight and be installed outdoors.

Provision must be made so that the cabinet can be securely sealed with a padlock type meter seal and padlock when the cover is closed. No customer owned devices other than conductors and connectors will be allowed in the C.T. cabinet.

Instrument transformer cabinets with mechanical connectors (Similar to Milbank S1855-O or Cooper B-Line 78205139309) which support bar type current transformers are required.

All line conductors, including the neutral, shall pass through the instrument transformer cabinet. A neutral connector shall be installed by the customer to provide for the connection of the metering neutral. The customer shall mount all instrument transformers and make all primary connections. Secondary metering wires are furnished and installed by the Company.

A separate 1 ¼" minimum metallic conduit for secondary wires between instrument transformer cabinets and meter enclosures shall be furnished and installed by the customer. This conduit shall be either rigid metal conduit (RMC) or intermediate metal conduit (IMC) and be properly bonded to provide an effective ground. The maximum run of this conduit will be 35 feet.

The top of the cabinet shall be between 5 feet and 6 feet from finish grade.

### **SECTION XV**

## CUSTOMER EQUIPMENT

### 1501. General

Electric service must not be used in such manner as to cause unusual fluctuations or disturbances in the Company's supply system, and in the case of violation of this rule the Company may discontinue service, or require the customer to modify his installation and/or equip it with approved controlling devices.

### 1502. Motors

Individual motors in excess of 5 hp and multiple motors totaling greater than 10 hp will not normally be served by a single phase service. Review by T&D Engineering is required if attempting to serve motors larger than the aforementioned by a single phase service.

The Company reserves the right to refuse service to polyphase installations totaling less than 10 hp. Furthermore, it is required that T&D Engineering approve all installations utilizing motors in excess of 5 hp

### 1503. Power Factor Correction

All customers whose rated capacity of electrical equipment exceeds 50 horsepower shall maintain an average power factor of 85 per centum for each month. If such power factor is less than 85 per centum in any case, the Company may request the customer to make such changes in or additions to his/her equipment as will bring the power factor to at least 85 per centum. If such changes or additions are not made within three months after such request, then until such changes or additions are made, the monthly bill, so calculated under the rate applicable to the particular service, shall be multiplied by one of the following constants:

Average Monthly Power Factor	Constants
.85 to .81	1.00
.80 to .76	1.02
.75 to .71	1.05
.70 to .66	1.08
.65 to .61	1.12
.60 to .56	1.18
.55 to .51	1.24
.50 or less	1.33

The use of equipment by the customer for power factor correction must conform to requirements of the Company as to electrical characteristics of equipment and its operation and control. The customer may be required to limit the size of his static capacitor installation or to maintain effective control of his capacitors or other corrective equipment in order to prevent the use of such equipment from causing excessive voltage at the service. Corrective equipment installed by the customer must be located on the load side of his service disconnecting device.

### 1504. Arc Welders

Before service is connected the Company will require a customer to obtain specific permission from the Company for the installation of an A.C. arc welder. The Company reserves the right to refuse the supply of service to A.C. arc welders which cause interference or disturb the quality of service to other customers.

### 1505. Antennas

Antennas and satellite receivers shall not be erected over or under the lines of the Company or attached to poles with electric service, as this practice would create a serious hazard.

### Versant Power's PLUS Program

PLUS—Private Line Utility Support—gives you complete coverage (materials and labor) for repair/replacement of any broken or worn out parts of your private electric line. At a monthly cost per pole, you can purchase worry free protection from large unexpected expenses due to storms or other damage causing incidents. Contact Versant Power to inquire about this unique program, and upon a satisfactory inspection of your line, you will be enrolled in our PLUS program. More about the PLUS program can be found at [WWW.VERSANTPOWER.COM](http://WWW.VERSANTPOWER.COM)

# LINE VOLTAGE VARIATIONS

When considering circuit loading and capital betterment projects or when evaluating customer complaints regarding voltage levels, please consider the following which is excerpted from the Maine Public Utilities Commission, Electric Utilities Service Standards designated as Chapter 32 of the Commission rules.

**VOLTAGE VARIATION:**

- (1) For service rendered principally for residential or commercial purposes the normal voltage variation shall not exceed plus or minus five percent ( $\pm 5\%$ ) from the standard voltage for any period longer than one (1) minute.

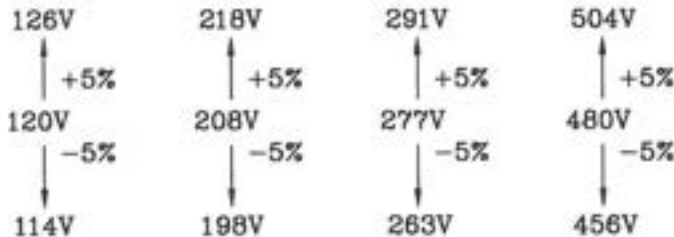

The standard allows greater variation than depicted above for service rendered for power purposes ( $\pm 10\%$ ) and service from transmission lines, however, essentially all of our distribution circuits must meet the above standard.

ANSI C84.1 further addresses the national voltage standard and sets 120/240 as the nominal system voltage, the minimum at 114 and the maximum at 126 volts. If the system voltage falls outside of the above limits, corrective action should be taken.

**NOTE:**

1 IF SERVICE VOLTAGE EXCEEDS  $\pm 5\%$  CONSULT T&D ENGINEERING.

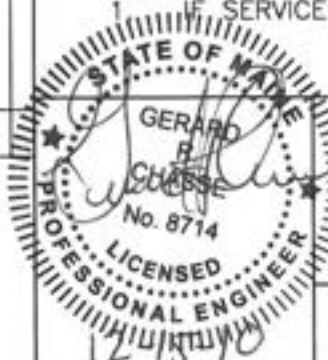

**DISTRIBUTION  
CONSTRUCTION  
STANDARDS**

**LINE VOLTAGE VARIATIONS**

**BANGOR HYDRO ELECTRIC Co.**

DRAWING

**105**

NO.	REVISION	DATE	CK
1	2009 REVISIONS & REFORMAT	3-8-10	GAN

NO.	REVISION	DATE	CK
1	2009 REVISIONS & REFORMAT	12-18-09	GAN

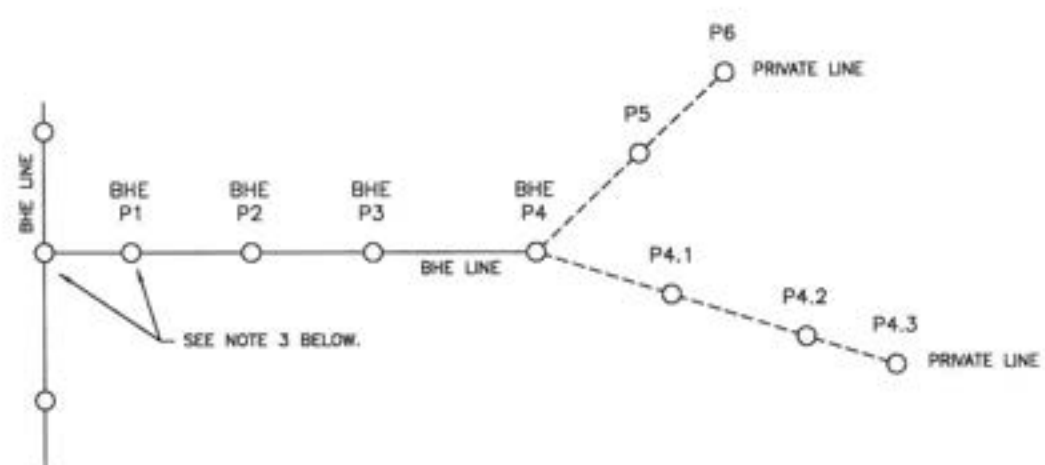
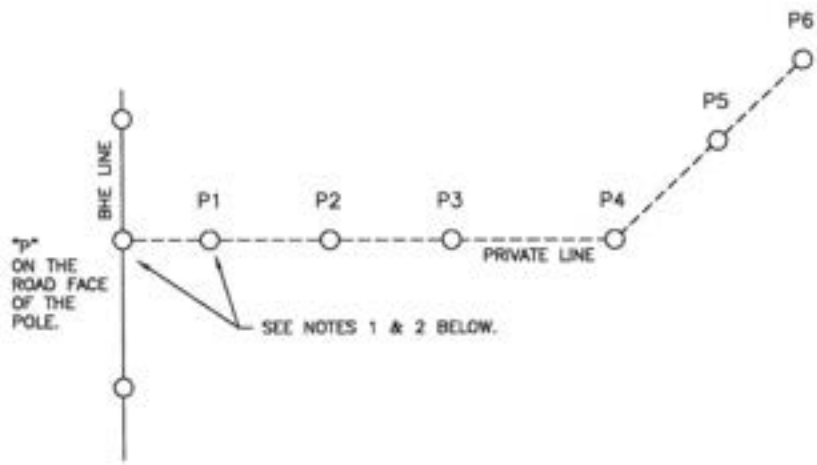

- NOTES:**
1. PRIVATE POLES SHOULD BE NUMBERED AS SHOWN ABOVE WITH A "P" AND THE APPROPRIATE NUMBER. B.H.E. Co. WILL PROVIDE NUMBER TAGS, TO BE PLACED BY CUSTOMER.
  2. THE B.H.E. Co. LINE POLE SHOULD BE TAGGED INITIALLY ON THE ROAD FACE OF THE POLE WITH A "P" TO INDICATE A PRIVATE LINE BRANCHES FROM THAT POINT.
  3. IF THE LINE IS PURCHASED BY B.H.E. Co. TO SERVE MULTIPLE CUSTOMERS AT A LATER DATE, THE LINE POLE ON THE ROAD SHOULD BE MARKED ON THE ROADSIDE WITH A "BHE" TAG ABOVE THE "P". IN ADDITION AT LEAST THE FIRST POLE ON THE LINE SHOULD HAVE THE "BHE" TAG PLACED ABOVE THE "P1". ALL OTHERS MAY BE SIMILARLY TAGGED.
  4. THE NUMBERS SHOULD BE LOCATED APPROXIMATELY 6' ABOVE GROUND ON THE POLE.

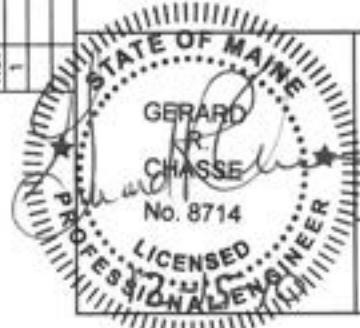

<b>DISTRIBUTION CONSTRUCTION STANDARDS</b>	<b>PRIVATE LINE POLE MARKING</b>	
	<b>BANGOR HYDRO ELECTRIC Co.</b>	<b>DRAWING 150</b>

	Insulated communication conductors and cable; messengers surge protection wires; grounded guys; neutral conductors.	Non-insulated communication conductors; secondary cables.	Supply cables over 750V; open supply conductors 0-750V.	Open Supply Conductors, Over 750V to 22kV
Where wires, conductors, or cables cross over or overhang				
1. Track rails of railroads. (Note 3)	27'	27'	28'	30'
2. Roads, streets, alleys; non-residential driveways, parking lots, and other areas subject to truck traffic.	18'	18'	18'	18.5'
3. Residential driveways.	15.5'	16'	16.5'	18.5'
4. Other land traversed by vehicles, such as cultivated, grazing, forest, orchard, etc.	15.5'	16'	16.5'	18.5'
5. Spaces and ways subject to pedestrians or restricted traffic only.	12'	12'	16.5'	18.5'
A.) Residential services to bottom of drip loop less than 150V to grd.		10'		
B.) Residential & commercial areas not subject to truck traffic less than 300V to grd.		12'		
6. Water areas not suitable for sailboating or where where sailboating is prohibited.	14'	14.5'	15'	17'
7. Water areas suitable for sailboating including lakes, ponds, reservoirs, tidal waters, rivers, streams and canals with an unobstructed surface.	<p>For controlled impoundments, the surface areas and corresponding clearances shall be based upon the design high water level. For other waters, the surface area shall be that enclosed by its annual high water mark, and clearances shall be used on the normal flood level. The clearances over rivers, streams, and canals shall be based upon the largest surface area of any 1 mile long segment which includes the crossing. The clearance over a canal, river, or stream normally used to provide access for sailboats to a larger body of water shall be the same as that required for the larger body of water.</p>			
(a) Less than 20 acres	31.5'	32.0'	32.5'	34.5'
(b) 20 - 200 acres	31.5'	32.0'	32.5'	34.5'
(c) 201 - 2000 acres	31.5'	32.0'	32.5'	34.5'
(d) Over 2000 acres	37.5'	38.0'	38.5'	40.5'
8. Public or private land and water areas posted for rigging or launching sailboats.	<p>Clearance above ground shall be 5 ft. greater than in 7 above, for the type of water areas served by the launching site.</p>			
Where wires, conductors, or cables run along and within the limits of highways or other road rights-of-way but do not overhang the roadway.				
9. Roads, streets, or alleys	15.5'	16'	16.5'	18.5'

- NOTE:** 1. These are minimum clearances per NESC. See NESC Table 232-1.  
2. For all other clearances on circuits above 22kV to ground, contact T&D Engineering.  
3. Additional clearance requested by rail company.



**DISTRIBUTION  
CONSTRUCTION  
STANDARDS**



**VERTICAL CLEARANCES OF WIRES  
ABOVE GROUND, ROADWAY, RAIL  
OR WATER SURFACES @ 120°F**

**LAST REVISED**  
8/30/2020

**DRAWING**  
201

NO.	REVISION	DATE	CK
NO.	REVISION	DATE	CK
NO.	REVISION	DATE	CK
NO.	REVISION	DATE	CK
NO.	REVISION	DATE	CK

MINIMUM CLEARANCE 12" IN SPAN, 4" ON BUILDING.

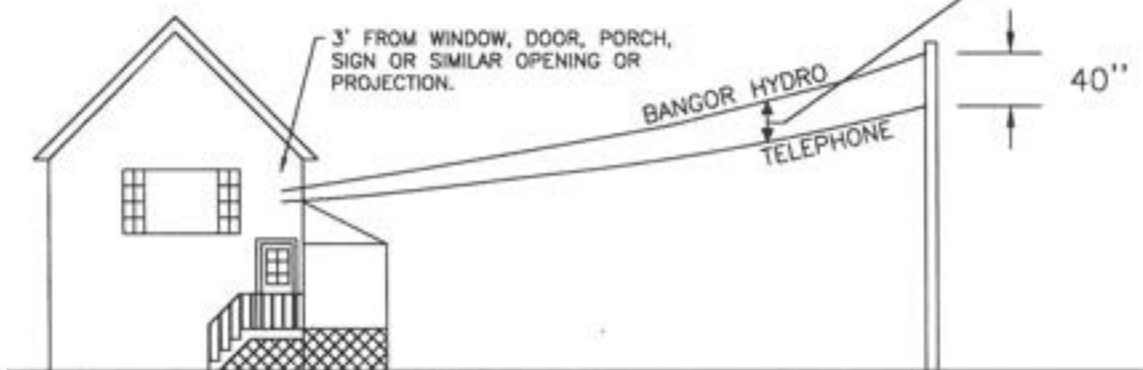

It is Company practice not to cross roofs with energized conductors where other alternatives are available. See Rule 234 in NESC. (or see BHE drawing 203.1)

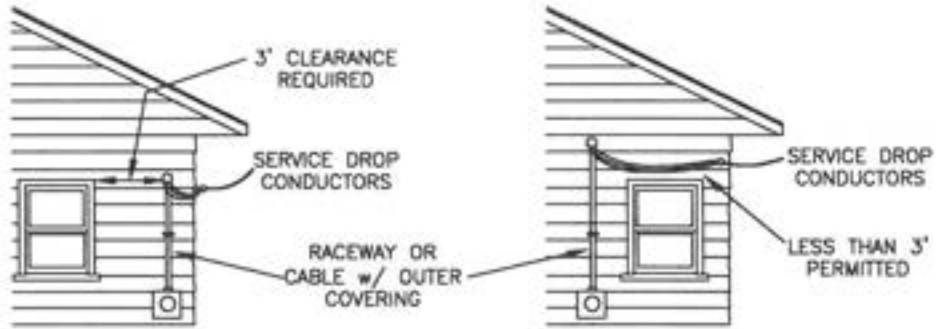

**Clearances from building openings**

Service conductors shall have a clearance of not less than 3' from windows, doors, fire escapes, or similar locations. **EXCEPTION:** Conductors run above the top level of a window shall be permitted to be less than 3' ft. from the window. See NEC Article 230-9.

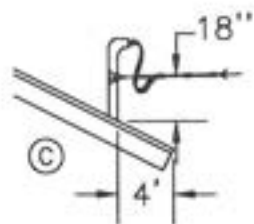
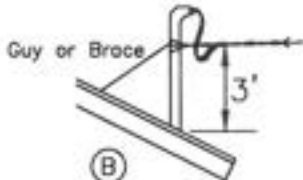
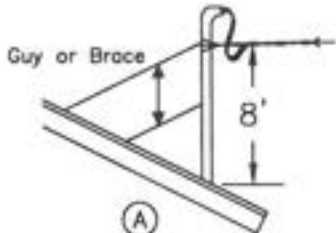

**Roof Clearances**

- "A" - More than 300 volts, 8' clearance is required.
- "B" - 300 volts or less, 3' minimum, clearance is permitted if roof slope is not less than 4" x 12".
- "C" - 300 volts or less, 18 in. clearance is permitted if conductors pass over not more than 4' of roof overhang.

**NOTE:**

1. MUST BE GUYED IF POINT OF ATTACHMENT EXCEEDS 30" ABOVE TOP SUPPORT. USE MINIMUM 3/16" STEEL GUY WIRE WITH ADEQUATE ATTACHMENTS.
2. CUSTOMER TO PROVIDE THE POINT OF ATTACHMENT. POINT OF ATTACHMENT SHALL BE LOCATED BELOW THE WEATHERHEAD, A MAXIMUM OF 12". SEE STANDARD #2704 FOR DETAILS.

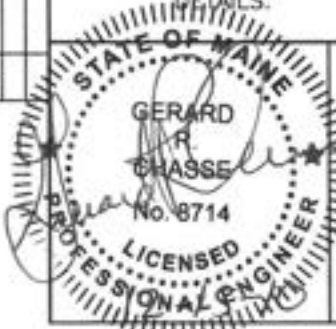

DISTRIBUTION  
CONSTRUCTION  
STANDARDS

MINIMUM CLEARANCES  
FOR SERVICE DROPS

BANGOR HYDRO ELECTRIC Co.

DRAWING  
202



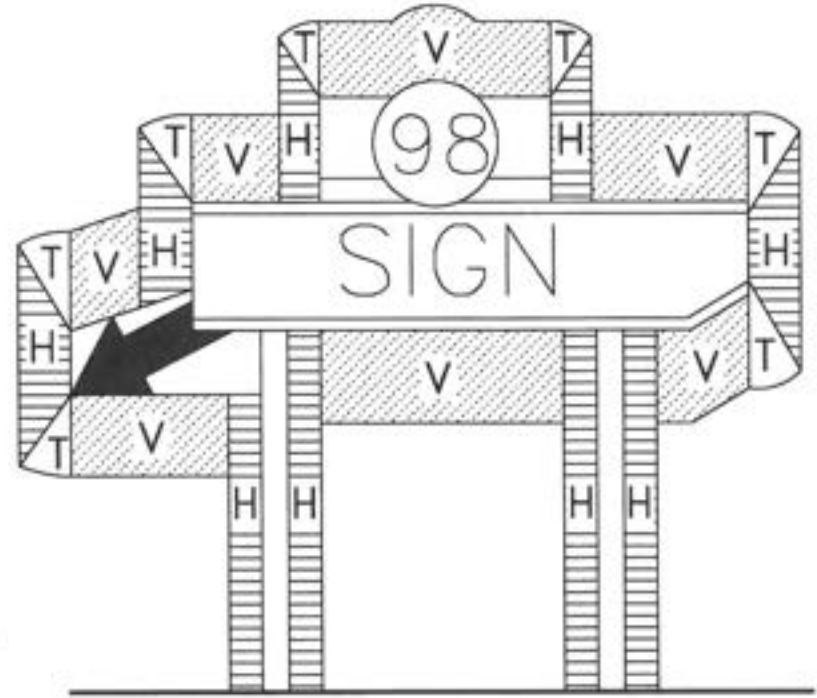
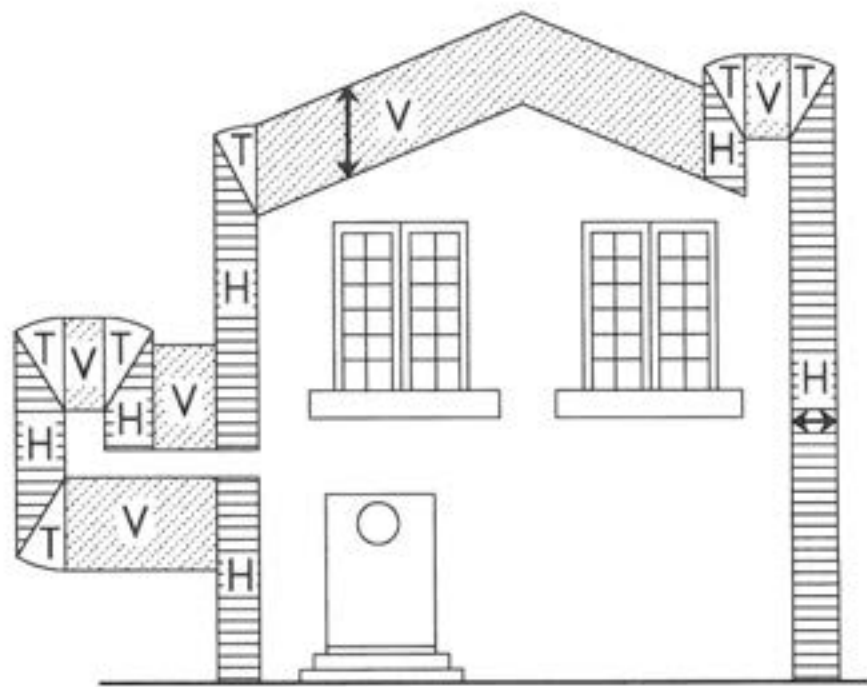

NO.	REVISION	DATE	CK

NO.	REVISION	DATE	CK
1	2009 REVISIONS & REFORMAT	12-21-09 GAN	



**LEGEND**

REGIONS WHERE CONDUCTORS ARE PROHIBITED	CONTROLLING CLEARANCE
H 	HORIZONTAL
V 	VERTICAL
T 	TRANSITIONAL= VERTICAL(ARC)

SEE STANDARD 203.2 FOR DIMENSIONS

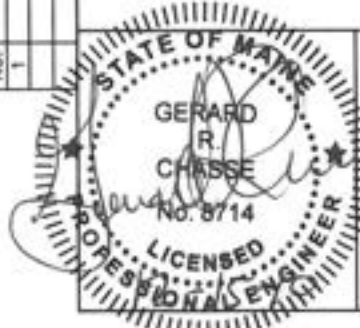

DISTRIBUTION  
CONSTRUCTION  
STANDARDS

CLEARANCES FROM BUILDINGS  
AND OTHER INSTALLATIONS  
EXCEPT BRIDGES

BANGOR HYDRO ELECTRIC Co.

DRAWING  
203.1

CLEARANCE AT REST OF WIRES, CONDUCTORS, CABLES, AND UNGUARDED RIGID LIVE PARTS ADJACENT BUT NOT ATTACHED TO BUILDINGS AND OTHER INSTALLATIONS EXCEPT BRIDGES. REFER TO NESC RULE 234.

THIS TABLE PERTAINS TO THE DRAWINGS ON STANDARD #203.1

BUILDINGS	GROUNDING GUYS SERVICE CABLES	OPEN SUPPLY CONDUCTORS 0 - 750V	OPEN SUPPLY CONDUCTORS 750 - 22KV	OPEN SUPPLY CONDUCTORS GREATER THAN 22KV
	CONDUCTOR CATEGORY 1&2	CONDUCTOR CATEGORY 3	CONDUCTOR CATEGORY 4	CONDUCTOR CATEGORY 4 NOTE 3
a. Horizontal	5'	7' NOTE 2	10' NOTE 2	
b. Vertical (NOTE 5) Over & under roofs and balconies not accessible to pedestrians (NOTE 1).	3'6"	10'6"	12'6"	
Over & under roofs and balconies accessible to pedestrians (NOTE 1).	11'	11'6"	13'6"	
Over roofs accessible to vehicles not exceeding 8 feet in height.	11'	11'6"	13'6"	
Over roofs accessible to vehicles exceeding 8' in height.	16'	16'6"	18'6"	

SIGNS, CHIMNEYS, BILLBOARDS, ANTENNAS, TANKS AND OTHER INSTALLATIONS	CONDUCTOR CATEGORY 1&2	CONDUCTOR CATEGORY 3	CONDUCTOR CATEGORY 4	CONDUCTOR CATEGORY 4 NOTE 3
a. Horizontal	3'6"	7' NOTE 2	10' NOTE 2	
b. Vertical over or under	3'6"	6'	8'	

NOTES:

1. A ROOF, BALCONY, OR AREA IS CONSIDERED ACCESSIBLE TO PEDESTRIANS IF THE MEANS OF ACCESS IS THROUGH A DOORWAY, RAMP, WINDOW, STAIRWAY OR PERMANENTLY MOUNTED LADDER. A PERMANENTLY MOUNTED LADDER IS NOT CONSIDERED A MEANS OF ACCESS IF IT'S BOTTOM RUNG IS EIGHT FEET OR MORE FROM THE GROUND OR OTHER PERMANENTLY INSTALLED ACCESSIBLE SURFACE.
2. REFER TO NESC RULE 234 OR T&D ENGINEERING FOR MINIMUM CLEARANCES.
3. REFER TO THE T&D ENGINEERING AS APPLICABLE FOR CLEARANCES OF THESE CONDUCTORS.
4. REFER TO STANDARD #203.3 FOR THE CONDUCTOR CATEGORY CLASSIFICATIONS.
5. IT IS NOT THE STANDARD OF B.H.E. TO CROSS CONDUCTORS OVER ROOFS AND BALCONIES, HOWEVER, IF DUE TO CONSTRUCTION CONSTRAINTS IT IS FOUND NECESSARY THESE CLEARANCES MAY BE USED.
6. REFER TO NESC 234-A.3 FOR AN EXPLANATION OF TRANSITIONAL CLEARANCE.

NO.	REVISION	DATE	CK
1	2009 REVISIONS & REFORMAT	3-8-10	GAN

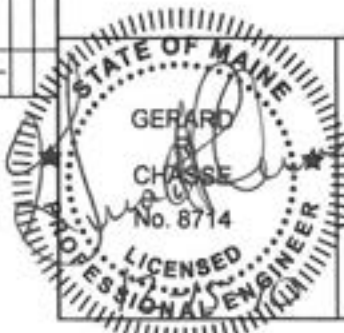

DISTRIBUTION  
CONSTRUCTION  
STANDARDS

CLEARANCES FROM BUILDINGS  
AND OTHER INSTALLATIONS  
EXCEPT BRIDGES

BANGOR HYDRO ELECTRIC Co.

DRAWING  
203.2

## CONDUCTOR CATEGORIES:

Conductor clearances vary depending on the voltage level and type of the conductor involved. These can be divided into 5 basic categories. Unguarded rigid live parts can also be placed into these categories, based on their voltage level. For clarity and simplicity, the following conductor categories are defined for use with the clearance guidelines.

### CATEGORY 1: Grounded guys,

Effectively grounded messengers,

Effectively grounded neutrals on 0 – 22 kV phase to ground circuits,

Effectively grounded concentric neutral cables operating at 0 – 22 kV phase to ground circuits,

Cables of any voltage having an effectively grounded continuous metal sheath or shield, supported on an effectively grounded messenger, or

Insulated communications conductors and cables.

### CATEGORY 2: Unguarded rigid live parts, 0 – 750 v,

Duplex, triplex, or quadruplex cable with an effectively grounded bare messenger, operating at 0 – 750 v,

Non-insulated communications conductors (bare or covered).

### CATEGORY 3: Open supply conductors 0 – 750 v,

Cables of any voltage, covered with a continuously auxiliary semiconducting shield in combination with metallic drainage, supported on and cabled together with an effectively grounded bare messenger,

Insulated, non-shielded cable operated at 5 kV phase to phase or 2.9 kV phase to ground, supported on and cabled together with an effectively grounded bare messenger. (Not equivalent to tree wire)

### CATEGORY 4: Unguarded rigid live parts, 750 v – 22 kV phase to ground,

Open supply conductors 750 v – 22 kV, phase to ground,

Unshielded, covered conductors 750v – 22kV, phase to gnd.

### CATEGORY 5: Open supply conductors exceeding 22 kV phase to ground.

Clearances shall be increased at the rate of 0.4" per kV in excess of 22kV. Refer to T&D Engineering where applicable.

**VOLTAGE DESIGNATIONS:** Unless otherwise specified, the voltage designations used in this guideline are phase to ground for effectively grounded circuits and other circuits where all ground faults are cleared by promptly de-energizing the faulted section, both initially and following subsequent breaker operations.

NO.	REVISION	DATE	CK

NO.	REVISION	DATE	CK
1	2008 REVISIONS & REFORMAT	12-21-09	GAN

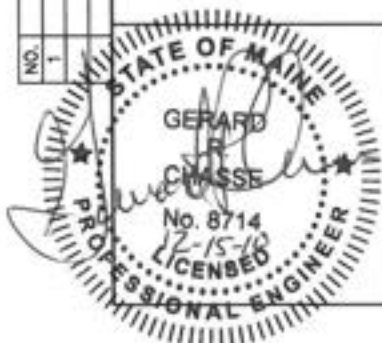

DISTRIBUTION  
CONSTRUCTION  
STANDARDS

CONDUCTOR CATEGORIES

BANGOR HYDRO ELECTRIC Co.

DRAWING  
203.3

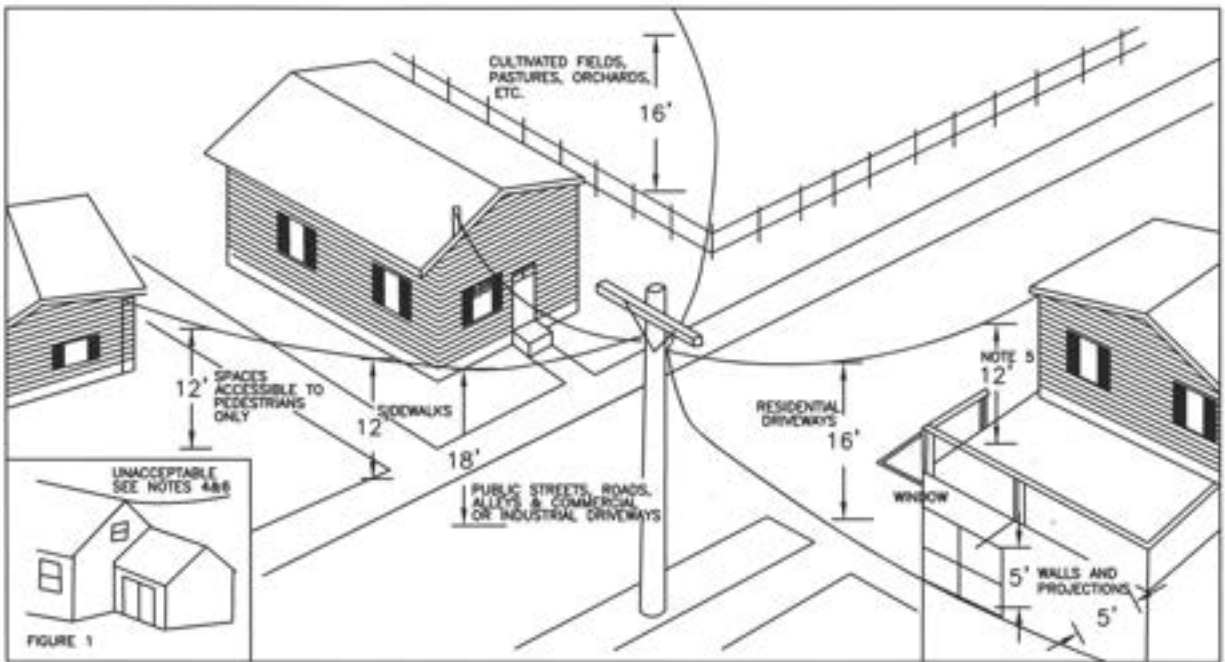

**NOTES:**

1. Dimensions shown above are based on NESC Rule 232 for vertical clearance, and NESC Rule 234 for horizontal clearance, with maximum wind displacement.
2. The above clearances are for services only. These are the minimum clearances required at 120°F final sag or 32°F and 1/2" ice, whichever produces the greatest sag (NESC Requirement).
3. Maintain 3'-6" vertical and horizontal clearances to signs, chimneys, billboards, radio and television antennas, tanks, other installations not classified as buildings, bridges and structures supporting lighting, traffic signals, and other lines without being attached to.
4. Service attachment located above building extension as shown in Figure 1 is not acceptable because the service connections cannot be directly reached from a ladder placed securely on the ground.
5. This clearance applies to flat roofs, balconies, and areas restricted to pedestrians only or to vehicles not exceeding 8' in height.
6. Crossing over the roof is unacceptable for Versant Power standards. Explore other options.
7. Where the height of a building does not permit the service drop to meet above clearances, the ground clearance for services 300 volts or less to ground and consisting of Triplex or Quadraplex cable may be reduced to 10.5' for insulated drip loops, 12.5' over residential driveways and 16' over commercial or industrial driveways.
8. Maximum height of weatherhead shall be no greater than 20' above ground where not accessible with a bucket truck.
9. Other utilities must be allowed for when considering the above clearances.



**DISTRIBUTION  
CONSTRUCTION  
STANDARDS**

  
**VERSANT  
POWER**

**MINIMUM CLEARANCES FOR SERVICES  
0-750 VOLTS**

<b>LAST REVISED</b>	<b>DRAWING</b>
07-14-2020	0204

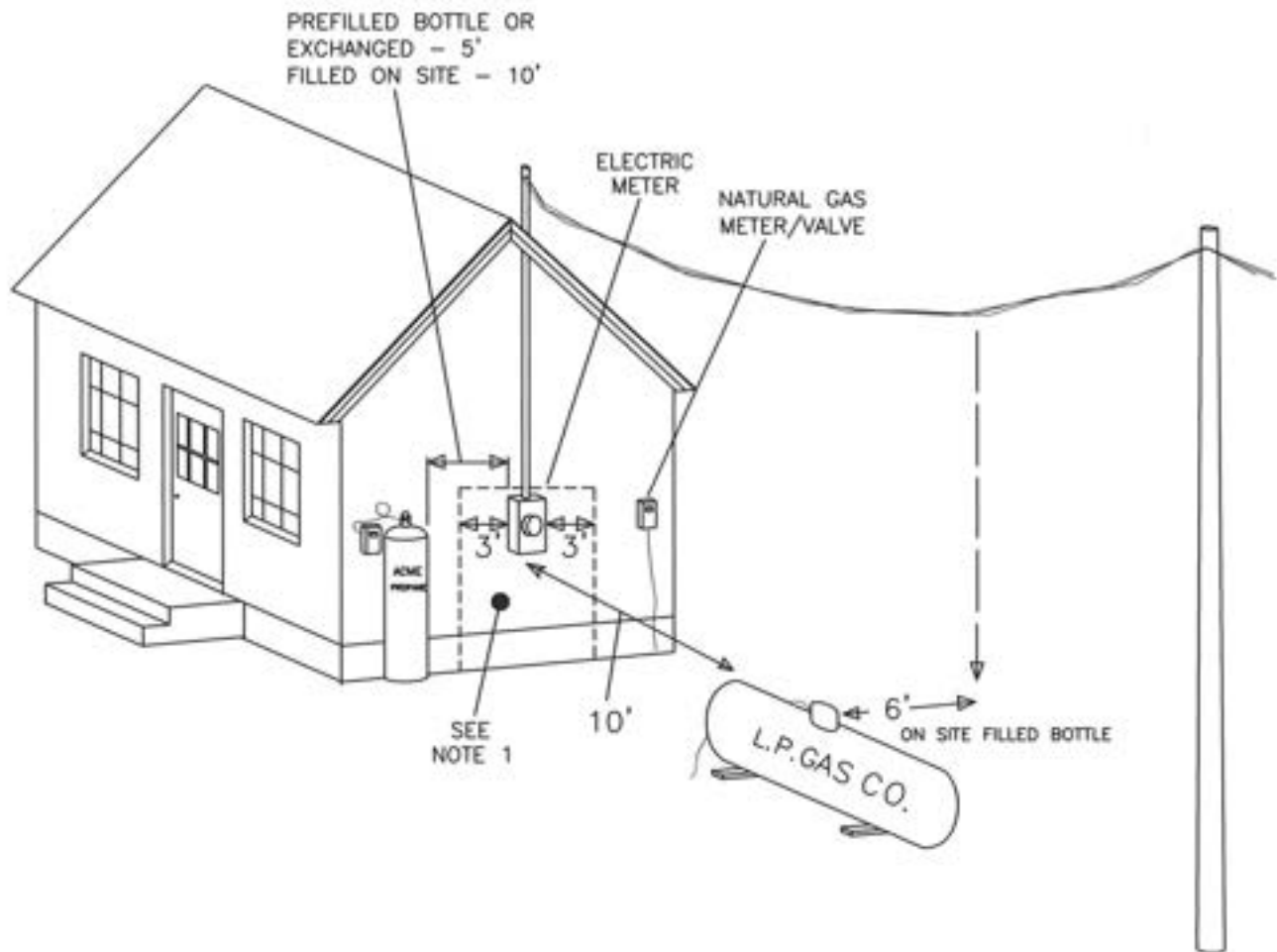

**NOTES:**

1. NO GAS EQUIPMENT, INCLUDING METERS, REGULATORS AND LINES SHALL BE PLACED IN THE ELECTRIC WORKSPACE, INDICATED AS THE AREA INSIDE THE DASHED LINES.
2. NO PART OF AN ABOVE GROUND L.P. GAS CONTAINER SHALL BE LOCATED IN THE AREA 6' HORIZONTALLY FROM A VERTICAL PLANE BENEATH OVERHEAD ELECTRIC POWER LINES. REFER TO NFPA 58.
3. THE DISTANCE MEASURED IN ANY DIRECTION FROM THE CONNECTION OF THE POINT OF DISCHARGE OF A CONTAINER PRESSURE RELIEF VALVE TO ANY SOURCE OF IGNITION (ELECTRIC METER) SHALL BE 10'.
4. NATIONAL GAS CODES REFER TO CLEARANCE FROM SOURCES OF IGNITION FOR METERS, SERVICE REGULATORS, RELIEF VALVES, FILL CONNECTIONS AND OTHER COMPONENTS. ELECTRIC METERS, DEPENDING ON FEATURES OF THEIR DESIGNS, MAY BE SOURCES OF IGNITION. THIS STANDARD IS INTENDED TO SERVE AS A GUIDELINE IN SPECIFYING POINT OF ELECTRIC SERVICE WHERE LIQUID PETROLEUM OR NATURAL GAS INSTALLATIONS ARE PRESENT. (A). INSIDE INSTALLATIONS SHOULD MAINTAIN CLEARANCE OF NOT LESS THAN 3 FEET. (B). OUTSIDE INSTALLATION SHOULD MAINTAIN CLEARANCE SHOWN ON FIGURE ABOVE. REFERENCE NATIONAL FUEL GAS CODE NFPA54, NFPA 58.



**DISTRIBUTION  
CONSTRUCTION  
STANDARDS**



**CLEARANCE BETWEEN  
ELECTRIC METERS/EQUIPMENT  
AND L.P. OR NATURAL GAS EQUIPMENT**

LAST REVISED  
07-14-2020

DRAWING  
0207

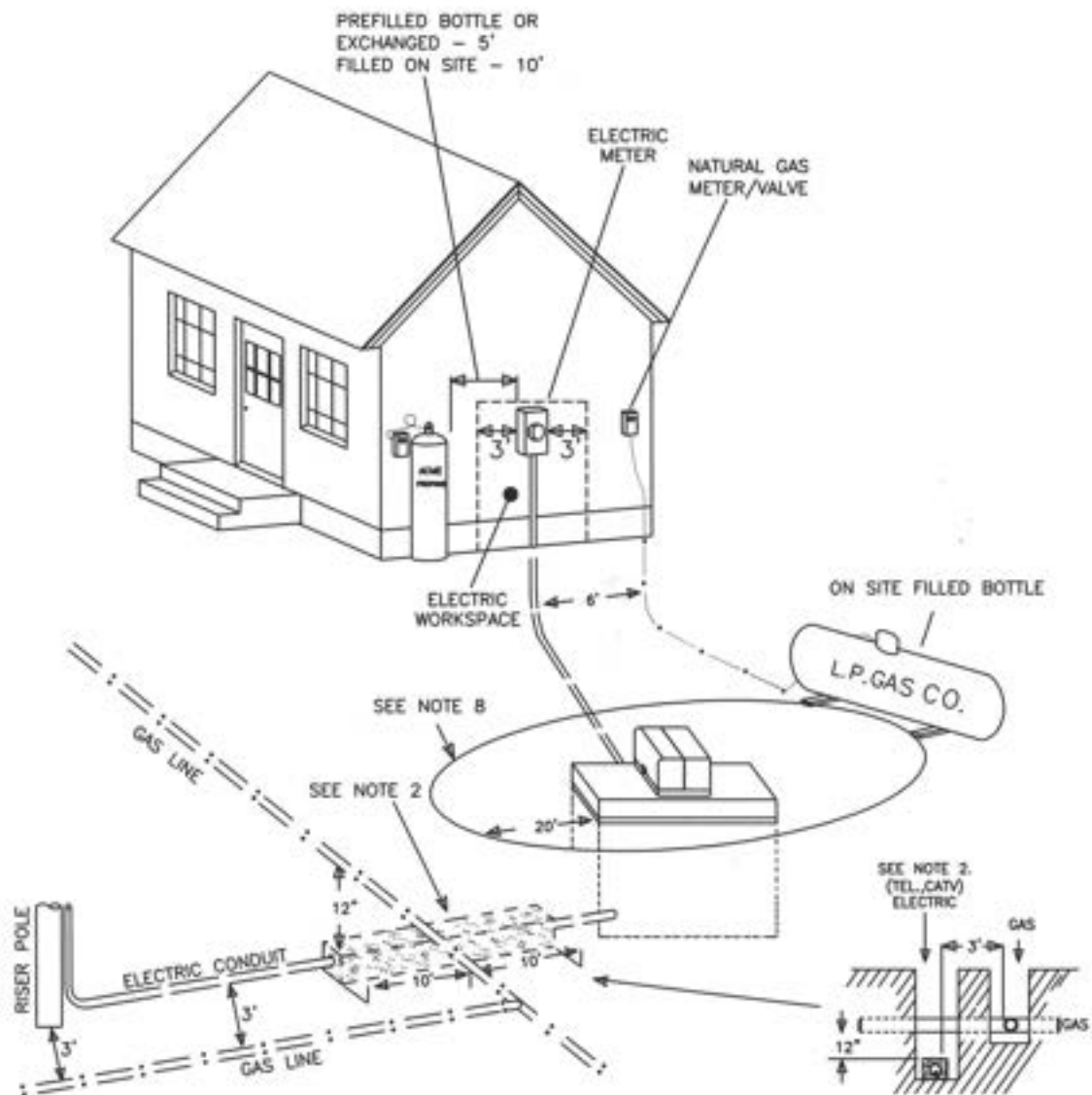

**NOTES:**

1. NO GAS EQUIPMENT, INCLUDING METERS, REGULATORS AND LINES SHALL BE PLACED IN THE ELECTRIC WORKSPACE, INDICATED AS THE AREA INSIDE THE DASHED LINES.
2. COMMUNICATIONS UTILITIES - 1' SEPARATION, HORIZONTAL & VERTICAL.
3. GAS, WATER & SEWER UTILITIES - 6' SEPARATION. CONSULT T&D ENGINEERING FOR CLOSER APPROACHES. CROSSINGS, IF POSSIBLE SHOULD BE DONE AT RIGHT ANGLES. ENCASE THE CONDUIT IN A 4" ENVELOPE OF CONCRETE FOR 10' ON EACH SIDE OF CROSSING. RIGID STEEL CONDUIT MAY BE SUBSTITUTED. GAS, WATER & SEWER LINES WILL NOT BE ALLOWED IN THE ELECTRICAL TRENCH. UNDISTURBED EARTH BARRIER SEPARATION IS REQUIRED BETWEEN TRENCHES. 1" VERTICAL SEPARATION OF ELECTRICAL DUCT FACILITY FROM GAS LINES REQUIRED (WHEN CROSSING).
4. SWIMMING POOLS (OR ASSOCIATED EQUIPMENT) - 10' SEPARATION. CONSULT T&D ENGINEERING FOR CLOSER APPROACHES.
5. OTHER STRUCTURES - 10' SEPARATION. CONSULT T&D ENGINEERING CLOSER APPROACHES TO COMPANY OWNED ELECTRIC SUPPLY CABLES. ELECTRIC SUPPLY CABLE SHALL NOT BE INSTALLED UNDER BUILDINGS.
6. MARKING TAPE REQUIRED IN ALL ELECTRICAL TRENCHES.
7. RAILROAD CROSSINGS - 5' VERTICAL CLEARANCE FROM TOP OF RAIL WHEN INSTALLED LONGTUDINALLY UNDER THE RAILROAD BED.
8. PADMOUNT TRANSFORMERS, SWITCHGEAR & JUNCTION CABINETS - 20' SEPARATION FOR GAS LINES, SWIMMING POOLS & PROPANE TANKS.



**DISTRIBUTION  
CONSTRUCTION  
STANDARDS**



**CLEARANCE BETWEEN  
ELECTRIC CABLES/EQUIPMENT  
AND L.P. OR NATURAL GAS EQUIPMENT**

**LAST REVISED**  
07-09-2020

**DRAWING**  
0208

**FRONT VIEW**

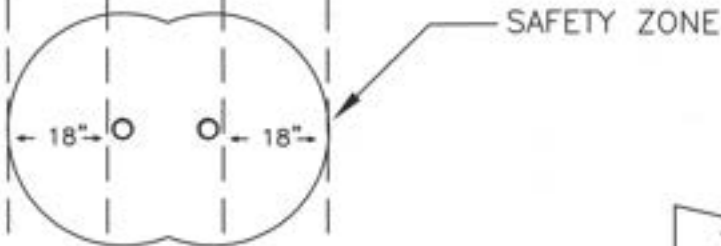
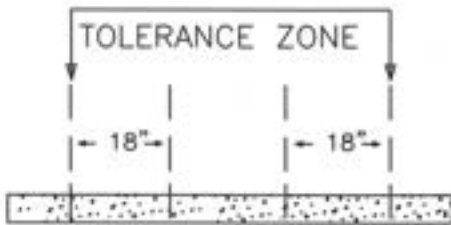

**MULTI-DIMENSIONAL VIEW**

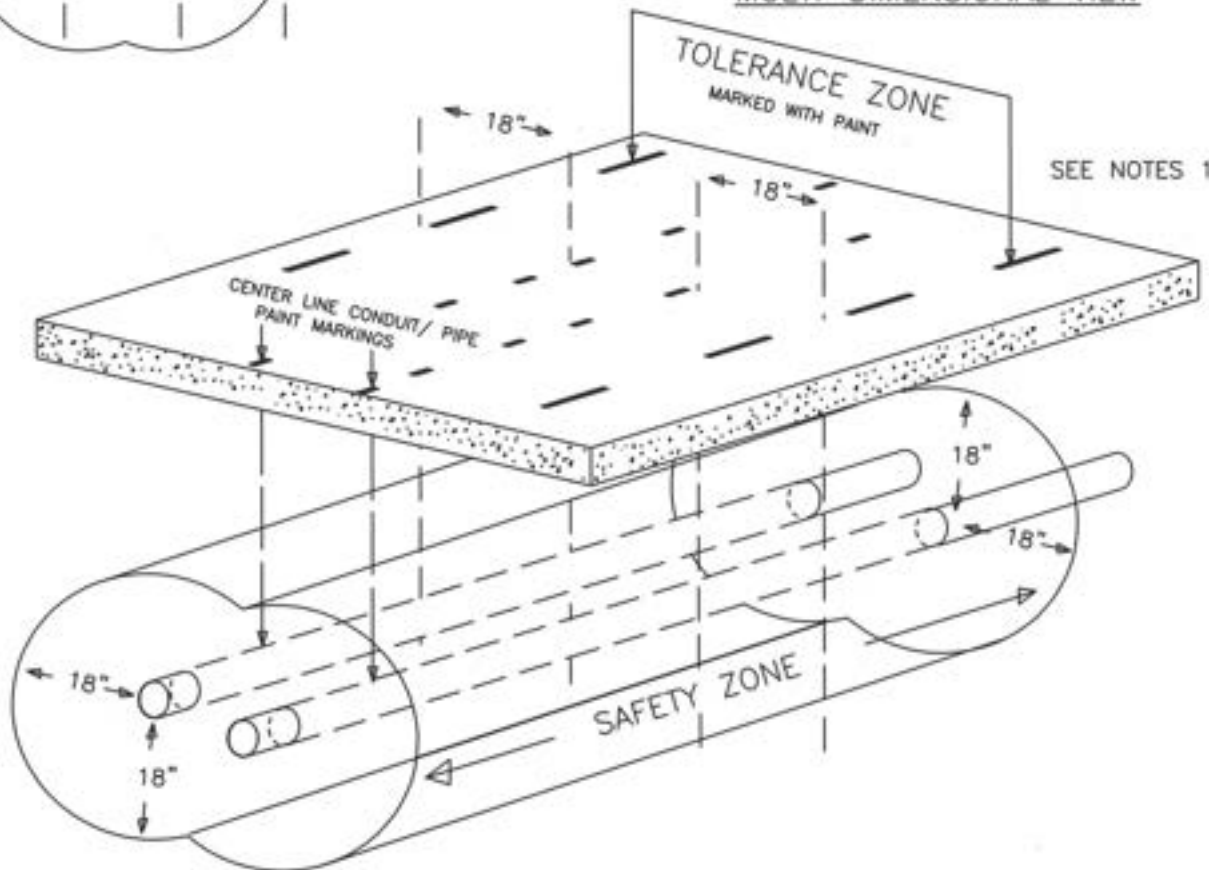

**NOTES:**

1. THIS IS AN EXAMPLE OF A CORRIDOR MARKED LOCATE.
2. ALWAYS HAND DIG WITHIN 18" IN ANY DIRECTION OF ANY UNDERGROUND LINE UNTIL THE LINE IS EXPOSED. WHEN CABLE DEPTH IS KNOW, MECHANICAL METHODS MAY BE USED FOR INITIAL SITE PENETRATION, SUCH AS REMOVAL OF PAVEMENT OR ROCK.



**DISTRIBUTION  
CONSTRUCTION  
STANDARDS**



**DIGSAFE SAFETY ZONE  
& TOLERANCE ZONE  
FOR ELECTRICAL FACILITIES**

**LAST REVISED**  
07-09-2020

**DRAWING**  
0209

FOR PRIVATELY OWNED FACILITIES ONLY

NOTES

1. THE FIBERGLASS 43"x38"x32" TRANSFORMER PAD IS SUITABLE FOR BOTH 7200/12470V AND 20/34.5KV SINGLE PHASE INSTALLATIONS.
2. PROVIDE COMPACTED GRAVEL BASE AND BACKFILL w/ ADEQUATE DRAINAGE SYSTEM w/ POSITIVE PITCH.
3. CONDUITS MUST HAVE END BELLS USED AT TERMINATION IN FOUNDATION.
4. TRANSFORMER MUST BE ACCESSIBLE BY TRUCK AND LOCATED ACCORDING TO STANDARD #2227.
5. PROVIDE FINISH GRADING AROUND FOUNDATION.
6. PROVIDE 15' MINIMUM SLACK FOR EACH CABLE IN WELL.
7. CUSTOMER SHALL FURNISH AND INSTALL 5/8"x8" COPPER CLAD GROUND ROD w/ AN 8' MINIMUM #4 STR. BARE COPPER PIGTAIL.
8. PROVIDE CONDUIT REQUIRED FOR METERING AS REQUIRED BY B.H.E. Co. METER DEPT.
9. NO METERING PEDESTALS MAY BE ATTACHED TO TRANSFORMER FOUNDATIONS.
10. B.H.E. Co. WILL NEVER ASSUME OWNERSHIP OF FACILITIES BUILT TO THIS STANDARD.

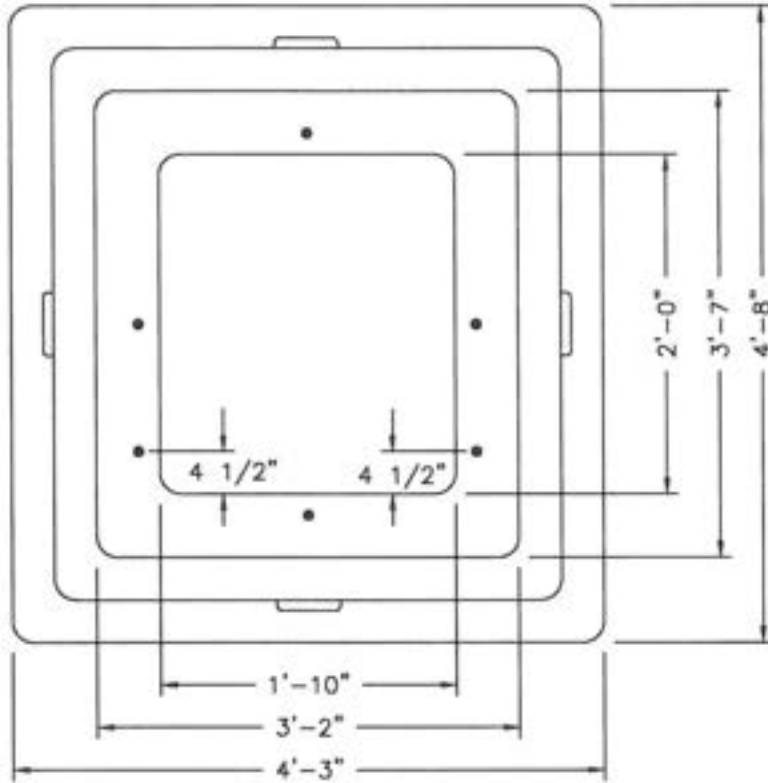

PLAN VIEW

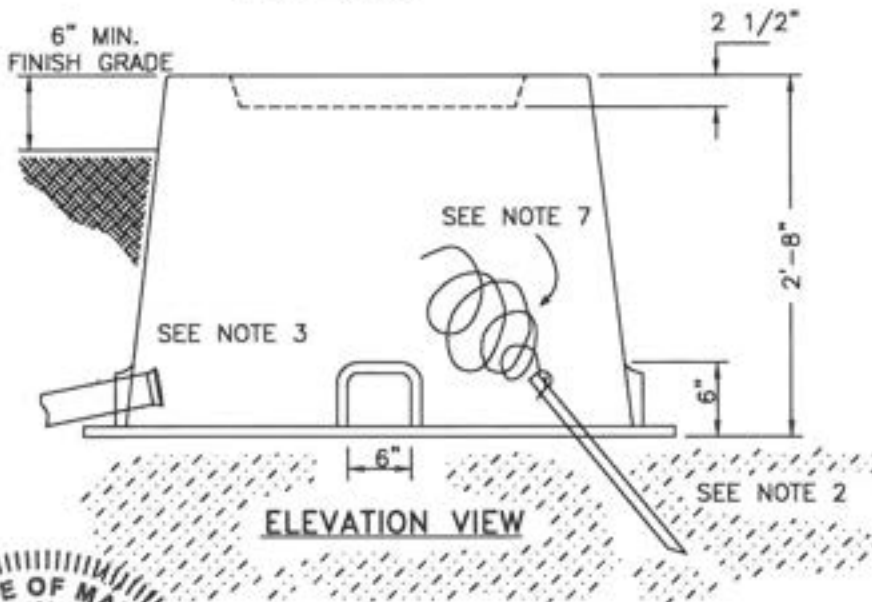

ELEVATION VIEW

NO.	REVISION	DATE	CK

NO.	REVISION	DATE	CK

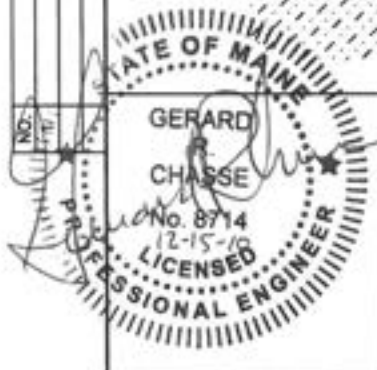

DISTRIBUTION  
CONSTRUCTION  
STANDARDS

FIBERGLASS SINGLE PHASE PADMOUNT  
TRANSFORMER FOUNDATION  
25KVA TO 50KVA  
FOR PRIVATE FACILITIES ONLY

BANGOR HYDRO ELECTRIC Co.

DRAWING  
2201



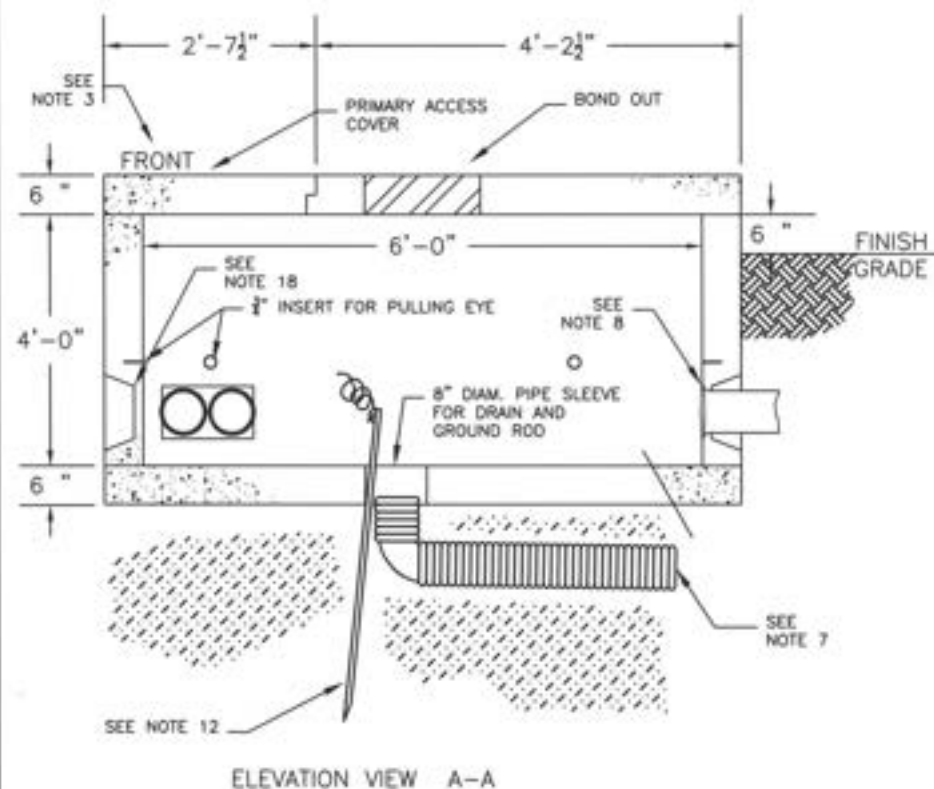
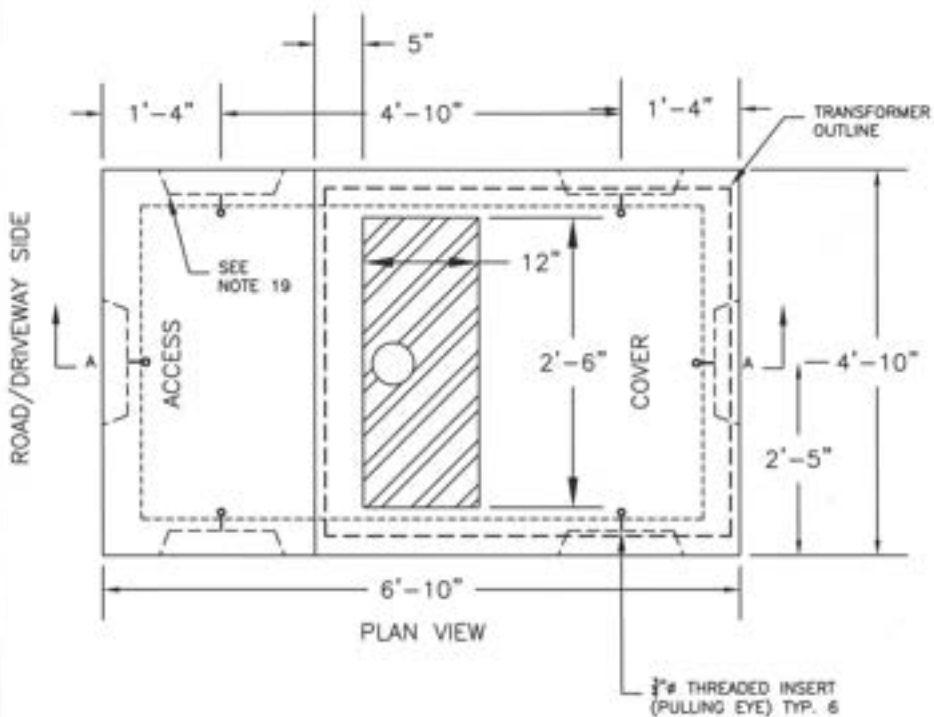

## NOTES

1. RECESSED LIFTING SLOTS(4) w/ STEEL BARS FOR LIFTING COVER.
2. CABLE BONDOUTS AS REQUIRED BY VERSANT POWER "FRONT" DENOTES THE SIDE ON WHICH THE ACCESS DOORS ARE LOCATED.
3. OVERALL HEIGHT MAY BE SHORTENED PER T&D ENGINEERING APPROVAL.
4. CONCRETE TO BE 4000 P.S.I. FOR 28 DAY TEST w/ MAXIMUM 3/4" BROKEN STONE.
5. REINFORCEMENT SHALL BE 4"x12" REINFORCEMENT WIRE MESH w/ #4 VERTICAL WIRE & #9 HORIZONTAL WIRE.
6. 3/4" ANCHORS FOR 3/4" EYE BOLTS(4) AT 90° ANGLES FOR CABLE PULLING.
7. PROVIDE COMPACTED GRAVEL BASE AND BACKFILL w/ ADEQUATE DRAINAGE SYSTEM w/ POSITIVE PITCH.
8. CONDUITS MUST HAVE END BELLS USED AT TERMINATION IN FOUNDATION AND BE GROUTED IN.
9. TRANSFORMER MUST BE ACCESSIBLE BY TRUCK AND LOCATED ACCORDING TO STANDARD #2227.
10. PROVIDE PULL ROPE FOR VERSANT POWER OWNED INSTALLATIONS.
11. PROVIDE 15' MINIMUM SLACK FOR EACH CABLE IN WELL.
12. CUSTOMER SHALL FURNISH AND INSTALL 5/8"x8' COPPER CLAD GROUND ROD w/ A 8' MINIMUM #4 STR. BARE COPPER PITGAL.
13. 4" MINIMUM CONDUIT SIZE FOR SINGLE OR THREE PHASE FACILITY.
14. PROVIDE 1-1/2" RMC OR IMC CONDUIT REQUIRED FOR METERING.
15. NO METERING PEDESTALS MAY BE ATTACHED TO TRANSFORMER FOUNDATION.
16. SEALANT AROUND BASE OF COVER WILL NOT BE PERMITTED.
17. VERSANT POWER RESERVES THE RIGHT TO REQUIRE A LARGER FOUNDATION FOR THIS RANGE OF TRANSFORMER SIZES.
18. BOND-OUTS UNDER PRIMARY ACCESS COVER FOR PRIMARY CONDUCTORS ONLY. SECONDARY CABLES TO BE INSTALLED IN REAR 2/3.
19. CONTRACTOR TO INSTALL METERING PER DWG'S 2714,2715, 2718, CONDUIT TO BE NO LONGER THAN 40'



DISTRIBUTION  
CONSTRUCTION  
STANDARDS



PRECAST SINGLE PHASE PADMOUNT  
TRANSFORMER FOUNDATION  
25 KVA THROUGH 167 KVA

LAST REVISED  
07-09-2020

DRAWING  
2202

**NOTES**

1. RECESSED LIFTING SLOTS(4) w/ STEEL BARS FOR LIFTING COVER.
2. CABLE BONDOUTS AS REQUIRED BY B.H.E. Co.
3. "FRONT" DENOTES THE SIDE ON WHICH THE ACCESS DOORS ARE LOCATED.
4. OVERALL HEIGHT MAY BE SHORTENED PER T&D ENGINEERING APPROVAL.
5. CONCRETE TO BE 4000 P.S.I. FOR 28 DAY TEST w/ MAXIMUM 3/4" BROKEN STONE.
6. REINFORCEMENT SHALL BE 4"x12" REINFORCEMENT WIRE MESH w/ #4 VERTICAL WIRE & #9 HORIZONTAL WIRE.
7. 3/4" ANCHORS FOR 3/4" EYE BOLTS(4) AT 90° ANGLES FOR CABLE PULLING.
8. PROVIDE COMPACTED GRAVEL BASE AND BACKFILL w/ ADEQUATE DRAINAGE SYSTEM w/ POSITIVE PITCH.
9. CONDUITS MUST HAVE END BELLS USED AT TERMINATION IN FOUNDATION.
10. TRANSFORMER MUST BE ACCESSIBLE BY TRUCK AND LOCATED ACCORDING TO STANDARD #2227.
11. PROVIDE PULL ROPE FOR B.H.E Co. OWNED INSTALLATIONS.
12. PROVIDE 15' MINIMUM SLACK FOR EACH CABLE IN WELL.
13. CUSTOMER SHALL FURNISH AND INSTALL 5/8"x8' COPPER CLAD GROUND ROD w/ A 8' MINIMUM #4 STR. BARE COPPER PIGTAIL.
14. 4" MINIMUM CONDUIT SIZE FOR THREE PHASE FACILITY.
15. PROVIDE CONDUIT REQUIRED FOR METERING AS REQUIRED BY B.H.E. Co. METER DEPT.
16. NO METERING PEDESTALS MAY BE ATTACHED TO TRANSFORMER FOUNDATION.
17. SEALANT AROUND BASE OF COVER WILL NOT BE PERMITTED.
18. B.H.E. Co. RESERVES THE RIGHT TO REQUIRE A LARGER FOUNDATION FOR THIS RANGE OF TRANSFORMER SIZES.

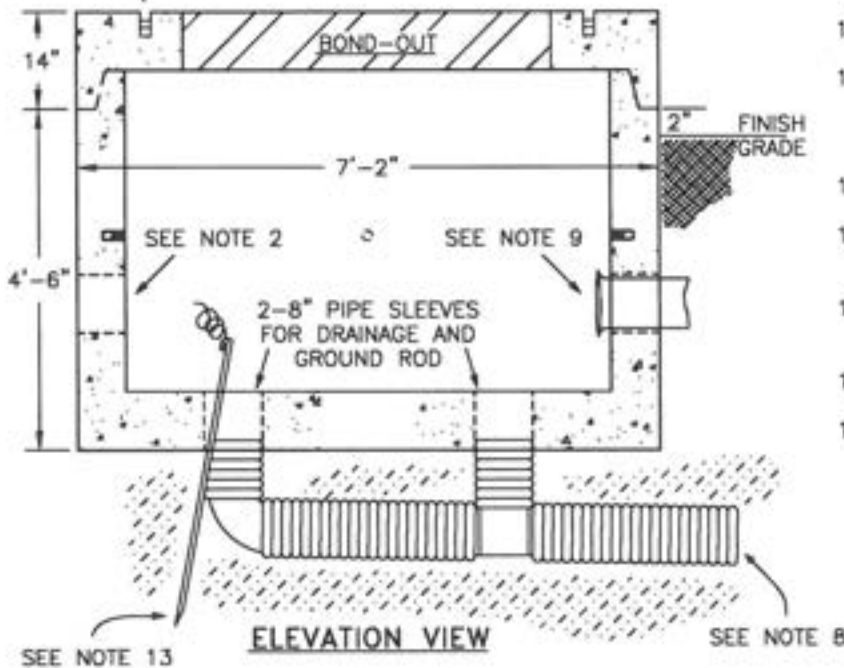
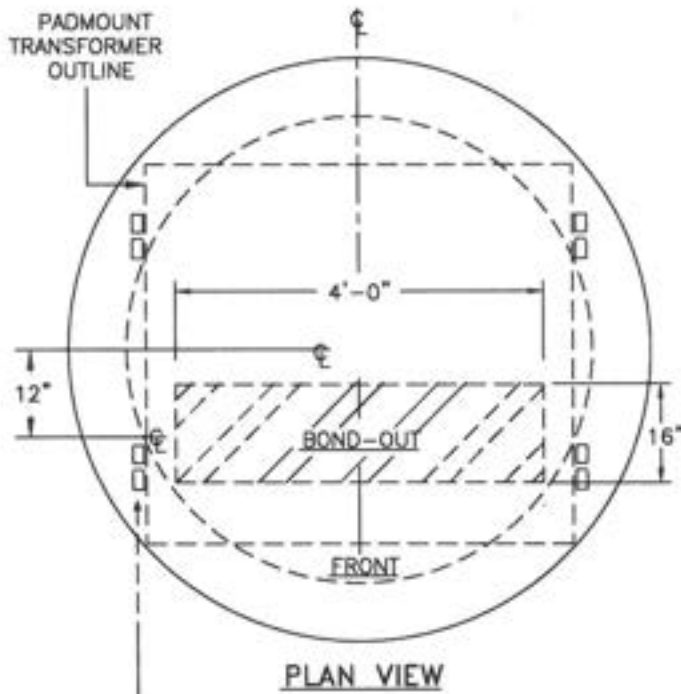

NO.	REVISION	DATE	CK

NO.	REVISION	DATE	CK

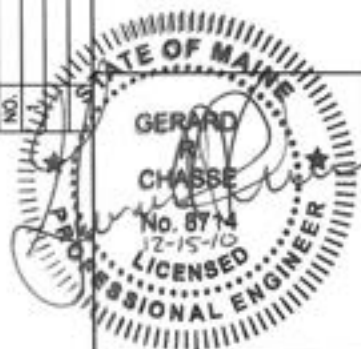

DISTRIBUTION  
CONSTRUCTION  
STANDARDS

PRECAST THREE PHASE PADMOUNT  
TRANSFORMER FOUNDATION  
75KVA THRU 750KVA

BANGOR HYDRO ELECTRIC Co.

DRAWING  
2203

### TYPICAL URD CONDUIT TRENCHES

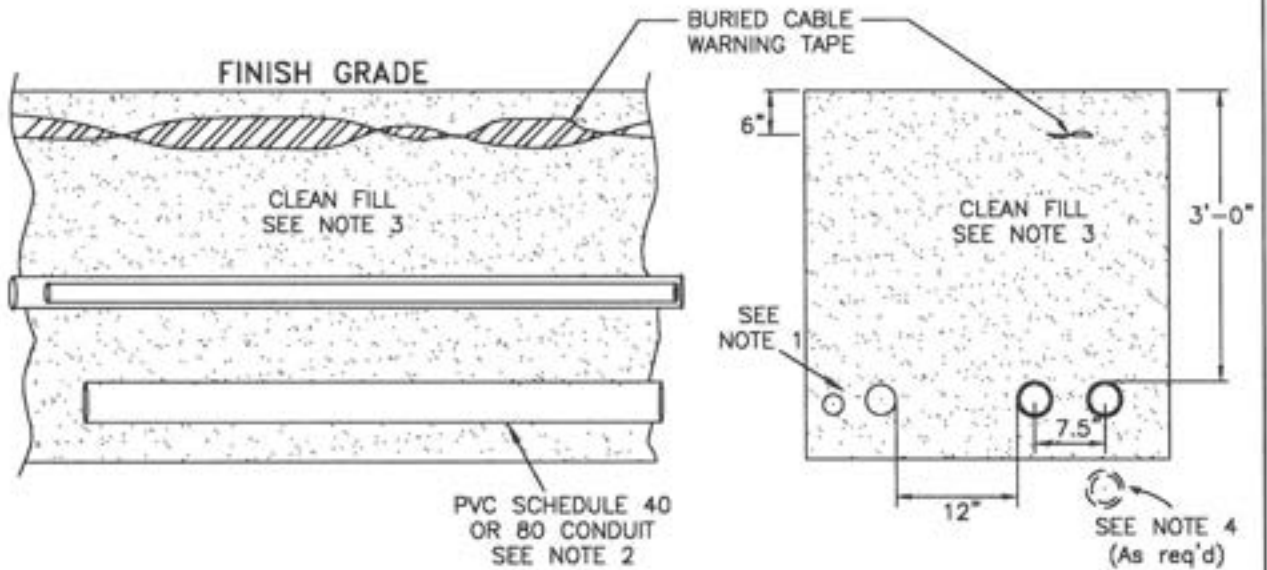

### CONCRETE ENCASEMENT

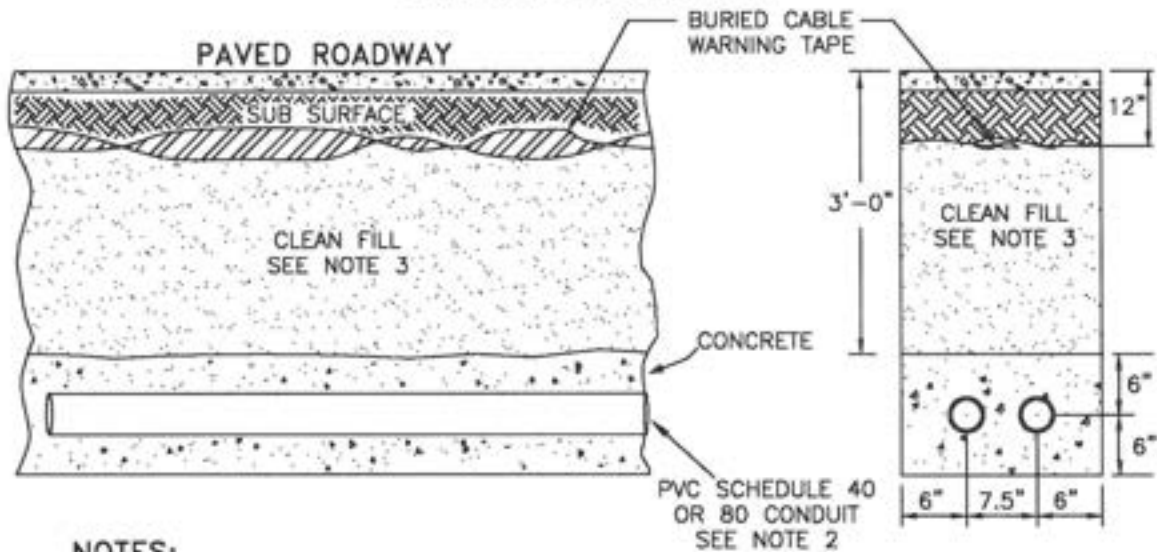

#### NOTES:

1. TELEPHONE AND CABLE T.V. PLUS OTHER COMMUNICATION CABLES AND DUCT NO WATER LINES, GAS LINES, OR SEWER LINES IN SAME TRENCH.
2. ONLY PVC SCH. 40 OR 80 CONDUIT UNLESS OTHERWISE APPROVED. MINIMUM ALLOWED CONDUIT SIZES:  
 PRIVATELY OWNED—SINGLE PHASE; 2" DUCT  
 THREE PHASE; 4" DUCT (5" FOR 35KV)  
 B.H.E. Co. OWNED—SINGLE PHASE FACILITIES: 4" DUCT  
 THREE PHASE FACILITIES: 4" DUCT (5" FOR 35KV)
3. CLEAN FILL, MUST CONTAIN NO CONSTRUCTION DEBRIS OR ROCK OVER 4" IN DIAMETER.
4. OPTIONAL TO SET BHE DUCT VERTICAL WHEN INSTALLING 2 DUCTS (MAINTAIN CLEARANCE AND DEPTH) TOP CONDUIT 3'.  
 CONCRETE ENCASED DUCTS MUST BE FORMED.

NO.	REVISION	DATE	CK

NO.	REVISION	DATE	CK

NO.	REVISION	DATE	CK

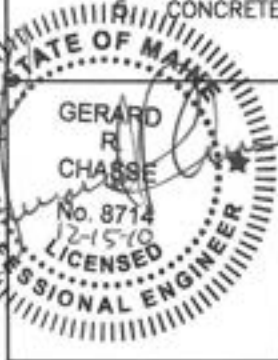

DISTRIBUTION  
CONSTRUCTION  
STANDARDS

TRENCH & CONDUIT DEPTH  
FOR PRIMARY UNDERGROUND  
INSTALLATIONS

BANGOR HYDRO ELECTRIC Co.

DRAWING  
2217

## CONDUIT RISER BRACKETS TYPICAL MULTI-CONDUIT RISERS

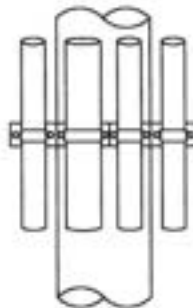
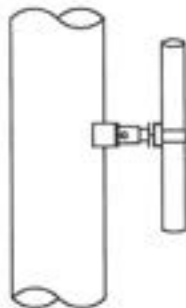
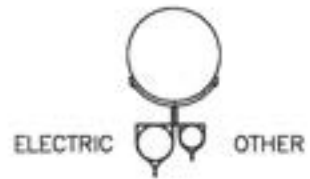
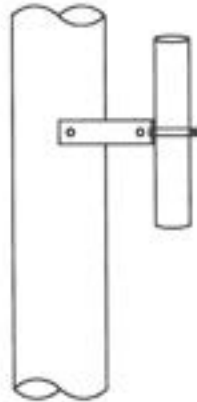

**NOTES:**

1. STAND-OFF BRACKETS REQUIRED.
2. ALL CONDUITS MUST HAVE 90° STEEL SWEEPS AT BASE OF POLES.
3. TWO BRACKETS REQUIRED FOR FIRST CONDUIT SECTION. BOTTOM BRACKET AS LOW AS POSSIBLE AND TOP BRACKET AT 8' MINIMUM ABOVE GROUND. MAXIMUM OF TWO ELECTRICAL CONDUITS PER INSTALLATION.

NO.	REVISION	DATE	CK

NO.	REVISION	DATE	CK
1	2009 REVISIONS & REFORMAT	8-30-10	GAN

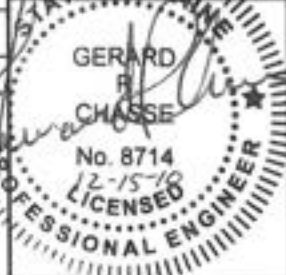

**DISTRIBUTION  
CONSTRUCTION  
STANDARDS**

**MULTI-CONDUIT RISERS  
ON B.H.E. Co. OWNED POLES**

**BANGOR HYDRO ELECTRIC Co.**

DRAWING  
**2218**

NO.	REVISION	DATE	CK

NO.	REVISION	DATE	CK

ELEVATION VIEW

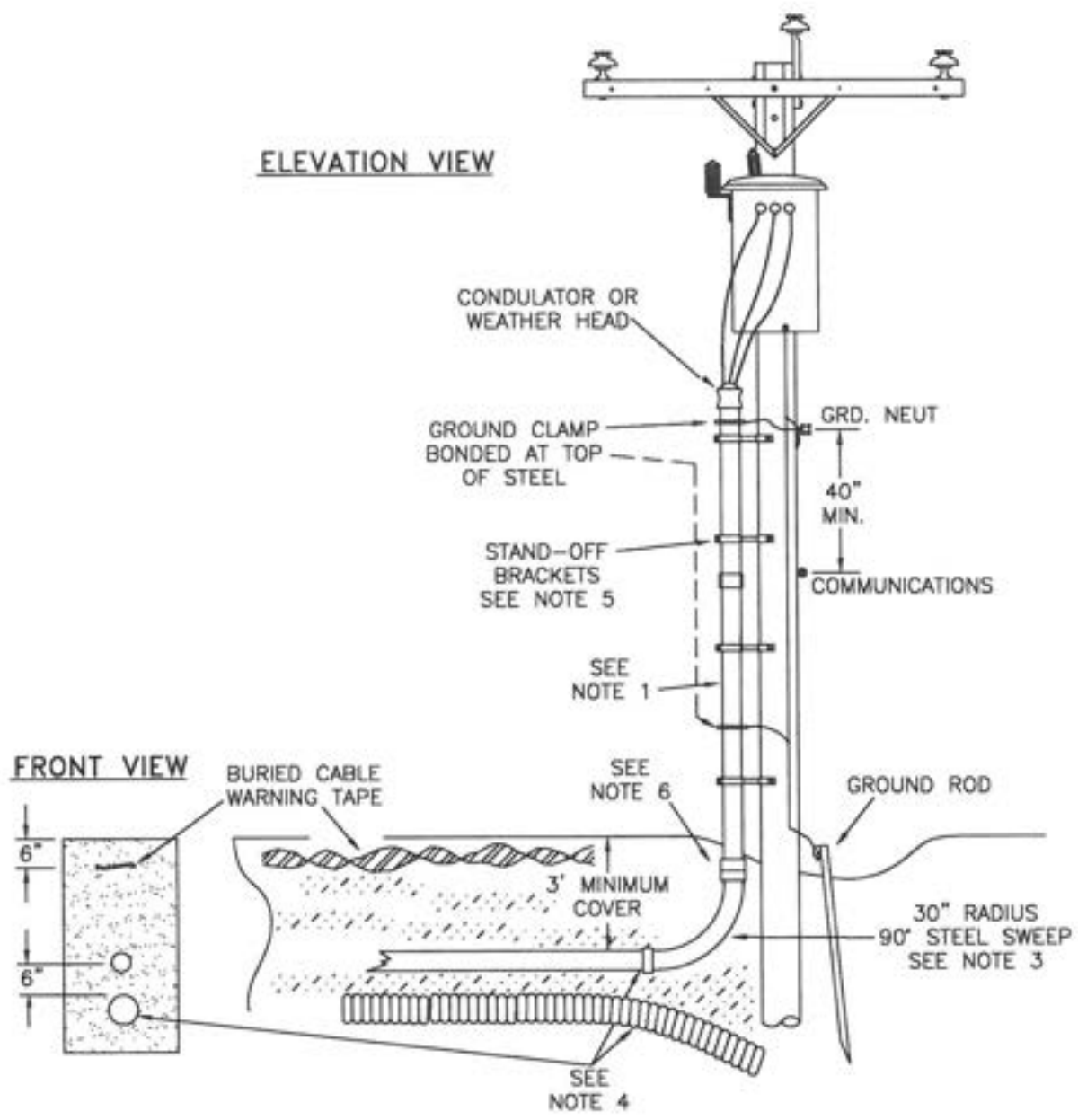

NOTES:

1. R.M.C.—RIGID METAL CONDUIT, GALV. -- I.M.C.—INTERMEDIATE METAL CONDUIT, GALV. SEE STANDARD #2217 FOR CONDUIT SIZE.
  2. CONDUIT NEED ONLY TO EXTEND ABOVE NEUTRAL WIRE, BUT ALWAYS MUST BE AT 3'-4" OR MORE ABOVE COMMUNICATION CABLES.
  3. STEEL SWEEP NOT NEEDED FOR DIRECT BURIED CABLE. HOWEVER A BUSHING IS REQUIRED.
  4. DRAINAGE HOLES IN DUCT LINE AND SUB DRAIN REQUIRED.
  5. STAND-OFF BRACKETS REQUIRED.
  6. THREADLESS COUPLING MAY BE USED WITH B.H.E. Co. APPROVAL.
- OF TWO CABLES PER PHASE. 500 KCM MAXIMUM CABLE SIZE.



DISTRIBUTION  
CONSTRUCTION  
STANDARDS

TERMINAL POLE EXCEPT PUBLIC WAY  
600V or LESS SERVICE  
SINGLE or THREE PHASE

BANGOR HYDRO ELECTRIC Co.

DRAWING  
2219

NO.	REVISION	DATE	CK

NO.	REVISION	DATE	CK

ELEVATION VIEW

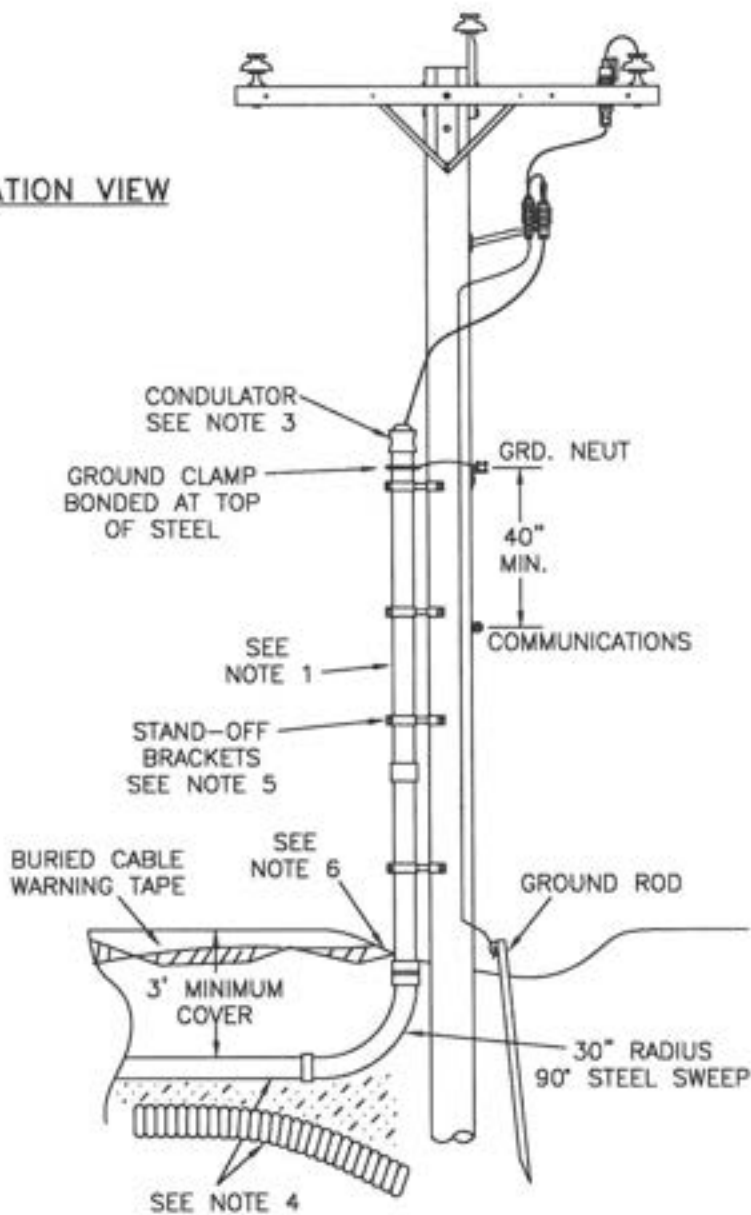

**NOTES:**

1. R.M.C.—RIGID METAL CONDUIT, GALV. -- I.M.C.—INTERMEDIATE METAL CONDUIT, GALV. SEE STANDARD #2217 FOR CONDUIT SIZE.
2. INSTALL TWO CONDUITS WITH ONE CABLE EACH IF LOOP FEED REQUIRED.
3. CONDUIT NEED ONLY TO EXTEND ABOVE NEUTRAL WIRE, BUT ALWAYS MUST BE 3'-4" OR MORE ABOVE COMMUNICATION CABLES.
4. DRAINAGE HOLES IN DUCT LINE AND SUB DRAIN REQUIRED.
5. STAND-OFF BRACKETS REQUIRED.
6. THREADLESS COUPLING MAY BE USED WITH B.H.E. Co. APPROVAL.

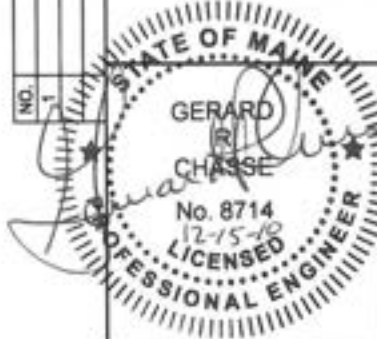

DISTRIBUTION  
CONSTRUCTION  
STANDARDS

TERMINAL POLE EXCEPT PUBLIC WAY  
SINGLE PHASE 15KV & 35KV

BANGOR HYDRO ELECTRIC Co.

DRAWING  
2223

NO.	REVISION	DATE	CK

NO.	REVISION	DATE	CK

NO.	REVISION	DATE	CK

ELEVATION VIEW

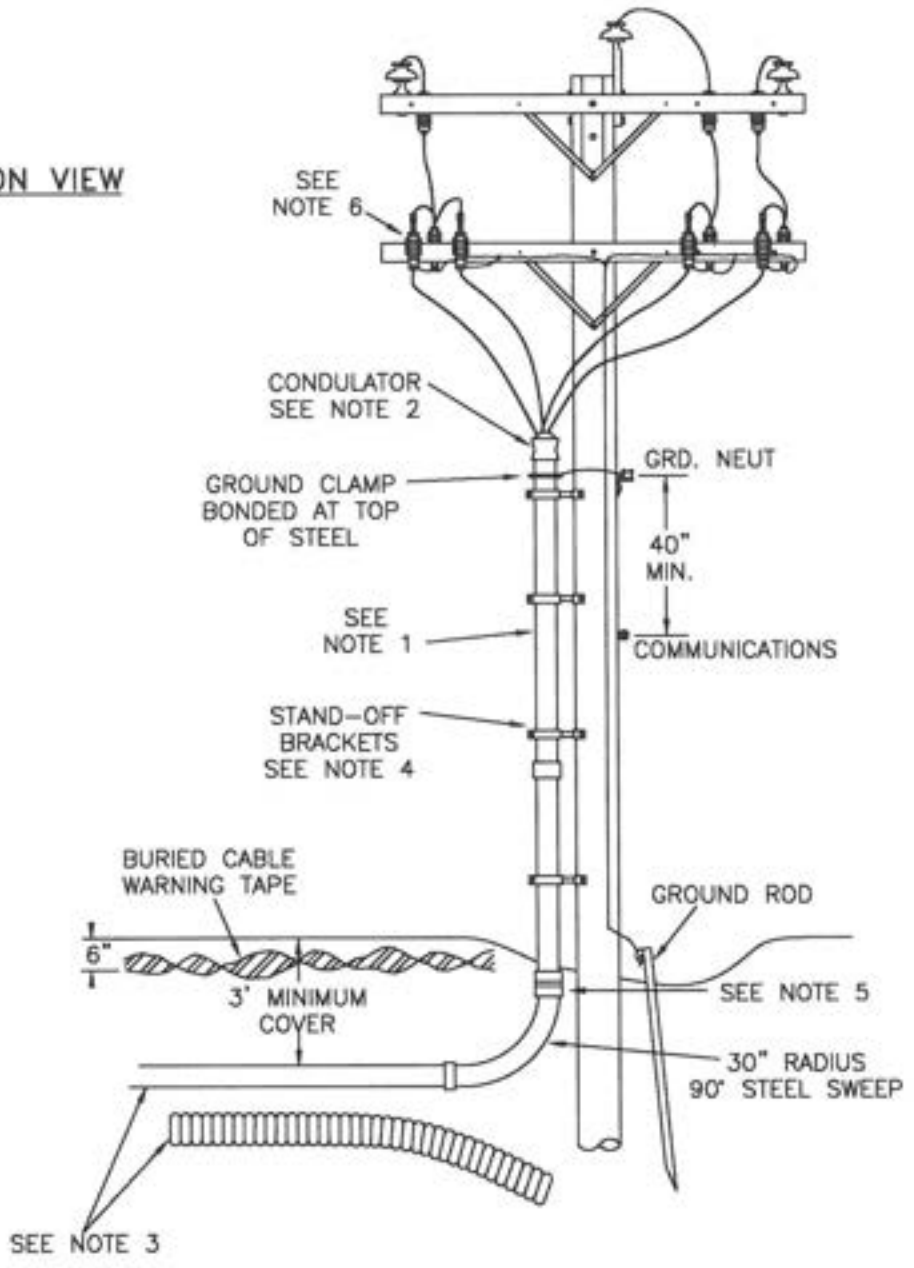

NOTES:

1. R.M.C.—RIGID METAL CONDUIT, GALV. -- I.M.C.—INTERMEDIATE METAL CONDUIT, GALV. SEE STANDARD #2217 FOR CONDUIT SIZE.
2. CONDUIT NEED ONLY TO EXTEND ABOVE NEUTRAL WIRE, BUT ALWAYS MUST BE 3'-4" OR MORE ABOVE COMMUNICATION CABLES.
3. DRAINAGE HOLES IN DUCT LINE AND SUB DRAIN REQUIRED.
4. STAND-OFF BRACKETS REQUIRED.
5. THREADLESS COUPLING MAY BE USED WITH B.H.E. Co. APPROVAL.
6. SPARE TERMINATOR IF NEEDED.

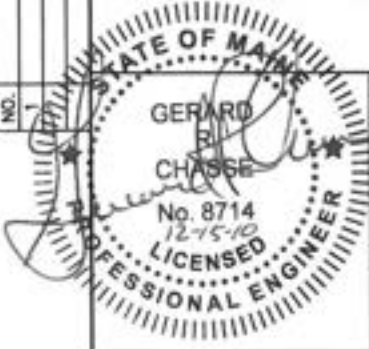

DISTRIBUTION  
CONSTRUCTION  
STANDARDS

TERMINAL POLE EXCEPT PUBLIC WAY  
THREE PHASE 15KV & 35KV

BANGOR HYDRO ELECTRIC Co.

DRAWING  
2225

TRANSFORMERS NEAR ROADWAYS (BOLLARDS MAY BE REQUIRED)

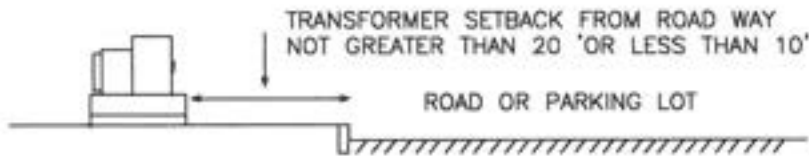

TRANSFORMERS IN PARKING LOTS (BOLLARDS REQUIRED)

BOLLARDS - 6" STEEL PIPE CONCRETE FILLED. MINIMUM EXPOSED BALLARD 4 FEET. MINIMUM BURIAL DEPTH 4'. BOLLARDS IN FRONT OF DOORS SHALL BE PLACED 4'-5' FROM FRONT OF DOOR.

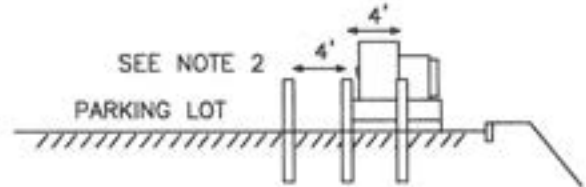
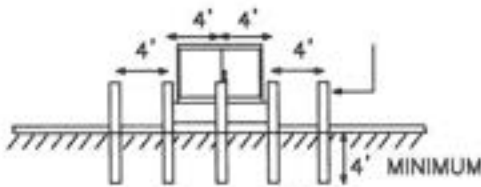

TRANSFORMERS NEAR STRUCTURES

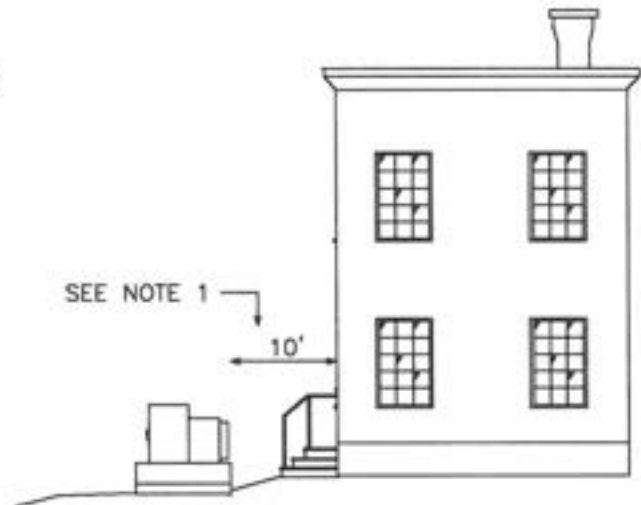
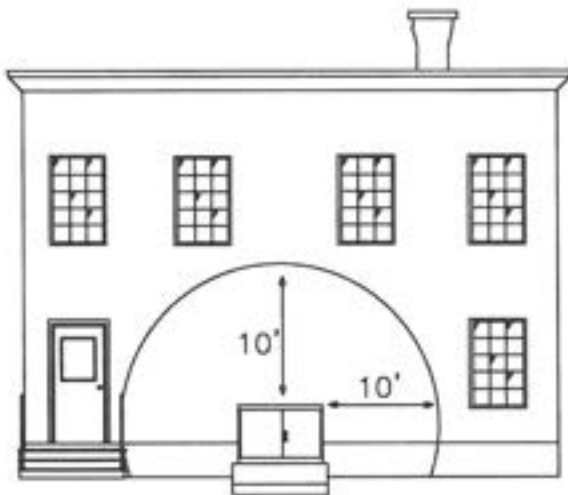

**NOTES:**

1. TRANSFORMER LOCATION CAN BE REDUCED TO 3' IF A FIRE WALL EXISTS ON THE EXTERIOR OF THE STRUCTURE PROVIDING NO DOORS, WINDOWS, OR OPENINGS ARE WITHIN 10'.
  2. TRANSFORMER CAN BE WITHIN A PARKING LOT PROVIDING PROTECTION FROM VEHICULAR TRAFFIC AND SNOW PLOWING CAN MAINTAINED.
3. 1500KVA AND LARGER PADMOUNT TRANSFORMERS SHALL BE 15' OR LESS FROM A ROADWAY.

NO.	REVISION	DATE	CK

NO.	REVISION	DATE	CK
	2009 REVISIONS & REFORMAT	8-30-10	GAN

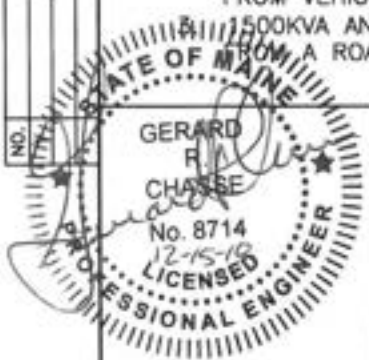

DISTRIBUTION  
CONSTRUCTION  
STANDARDS

PADMOUNT TRANSFORMERS  
LOCATIONS NEAR STRUCTURES  
& ROADWAYS

BANGOR HYDRO ELECTRIC Co.

DRAWING  
2227.1



NO.	REVISION	DATE	CK

NO.	REVISION	DATE	CK

NO.	REVISION	DATE	CK
	2009 REVISIONS & REFORMAT	3-9-10	GAN

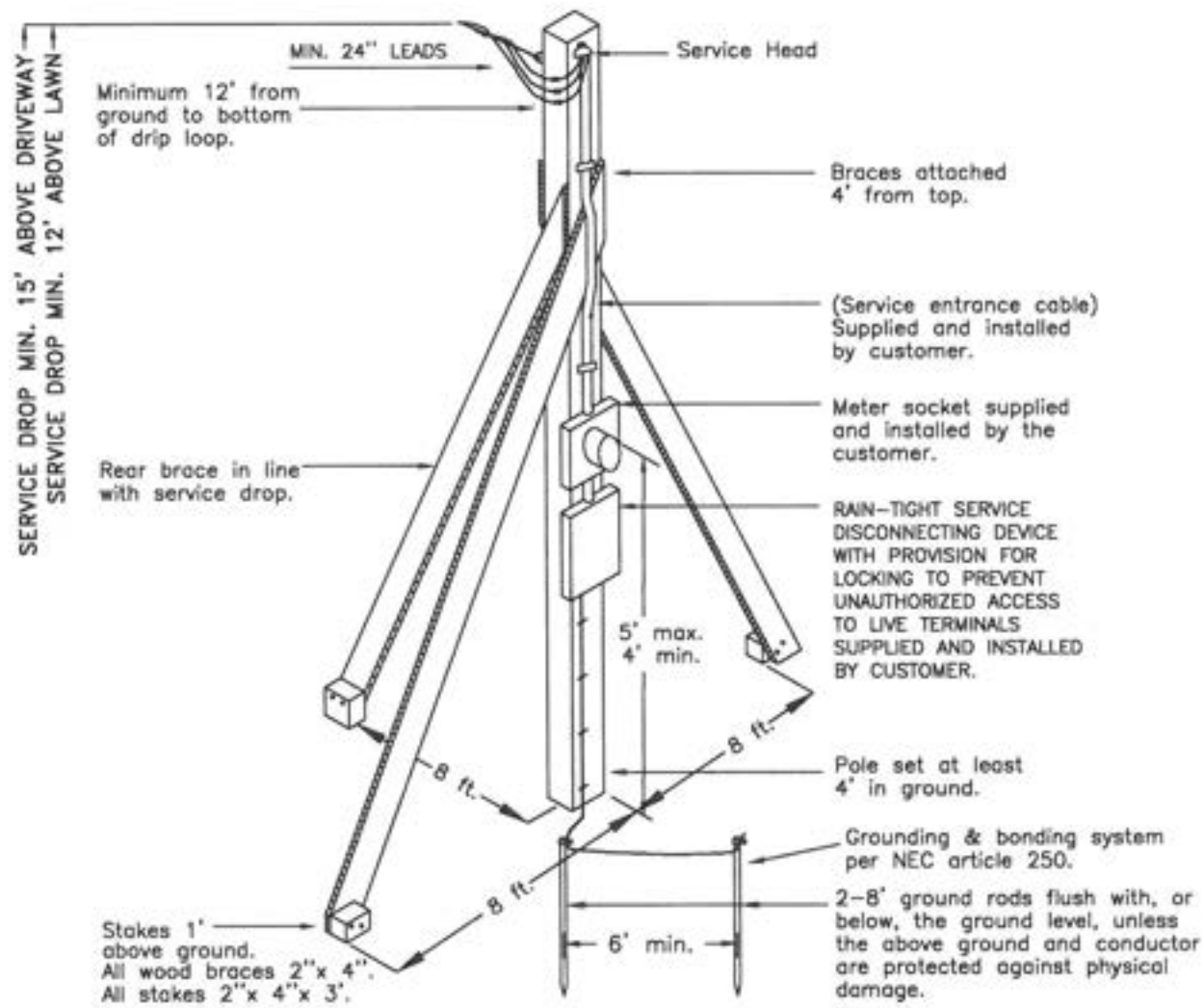

1. The service location and type of construction must be approved in advance by a B.H.E. company representative. All equipment to be owned and installed by the customer, except where designated.
2. Installation of temporary service on a construction shack having suitable height may be permitted with the approval of the local line department.
3. The pole of the temporary service structure must be at least 5" in diameter at the top, or a 6"x 6" timber (4"x 4" timber may be used when the distance to the service pole is 25' or less). TREES ARE NOT ACCEPTABLE. Distance over 75' may require pole and anchor.
4. The temporary pole must be tall enough to permit the drip loop to be at least 12' above the ground. Ground clearance for 120/240V & 120/208V services is 12'. Clearance for 277/480V service is 15'.
5. This structure shall not be used for road crossings. When on the opposite side of street from the B.H.E. Co. owned pole, the road crossing span shall be between conventional pole structures approved by B.H.E. Co.
6. All equipment, except the service drop, service drop connectors and the meter, shall be supplied, installed and maintained by the customer.

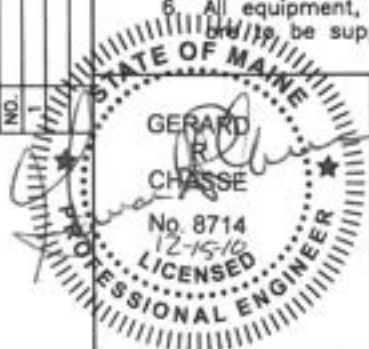

DISTRIBUTION  
CONSTRUCTION  
STANDARDS

TEMPORARY SERVICE STRUCTURE  
FOR USE DURING  
BUILDING CONSTRUCTION

BANGOR HYDRO ELECTRIC Co.

DRAWING  
2701

**NOTE:**

Where the voltage between conductors does not exceed 300V and the service passes above only the overhang portion of the roof and for a distance of not more than 4', then the minimum clearance is 1'-6". For all other conditions, refer to NEC para. 230-24(a). See Standard #202.

2" minimum rigid steel conduit (no PVC or EMT permitted). 2.5" conduit required for service drops longer than 100'. Must be guyed if point of attachment exceeds 30" above top support. Use minimum 3/16" steel guy wire with adequate attachments.

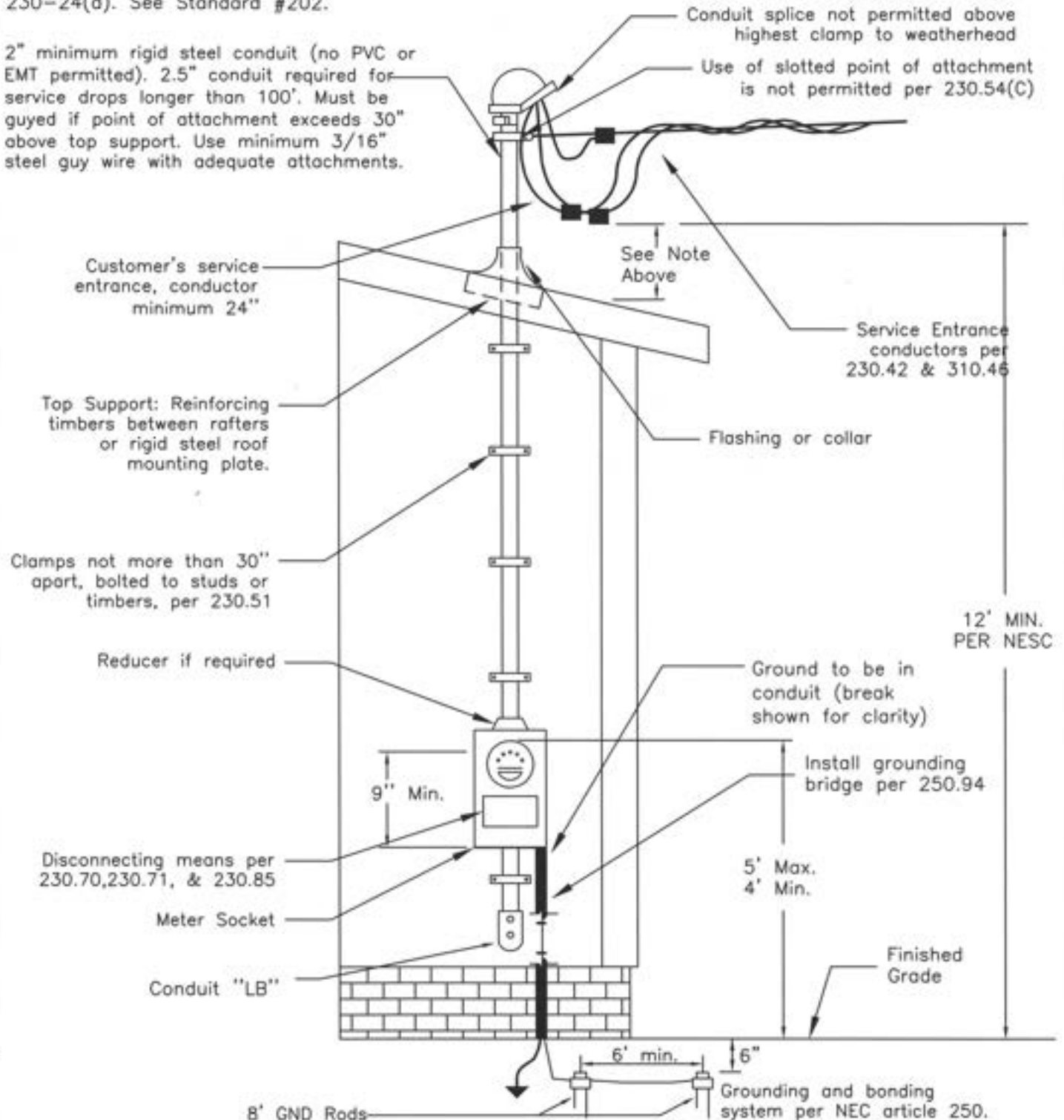

**DISTRIBUTION  
CONSTRUCTION  
STANDARDS**

**VERSANT  
POWER**

**RIGID STEEL MAST  
100 - 400A SERVICE  
TO LOW BUILDING**

<b>LAST REVISED</b> 07-09-2020	<b>DRAWING</b> 2702
-----------------------------------	------------------------

**NOTE:**

Where the voltage between conductors does not exceed 300 and the service passes above only the overhang portion of the roof and for a distance of not more than 4', then the minimum clearance is 1'-6". For all other conditions, refer to N.E.C. para. 230-24(a). See Standard #202.

2" minimum rigid steel conduit (no PVC or EMT permitted). 2.5" conduit required for service drops longer than 100'. Must be guyed if point of attachment exceeds 30" above top support. Use minimum 3/16" steel guy wire with adequate attachments.

Customer's service entrance, conductor minimum 24"

See Note Above

Flashing or Collar

Top Support: Reinforcing timbers between rafters or rigid steel roof mounting plate.

12' MINIMUM Per N.E.S.C.

Clamps not more than 30" apart, bolted to studs or timbers.

Reducer if required

9" Min.

5' Max.  
4' Min.

Meter Socket

Conduit "LB"

Finished Grade

8' GND Rods

6" min. 6" Grounding and bonding system per NEC article 250.

NO.	REVISION	DATE	CK

NO.	REVISION	DATE	CK

NO.	REVISION	DATE	CK

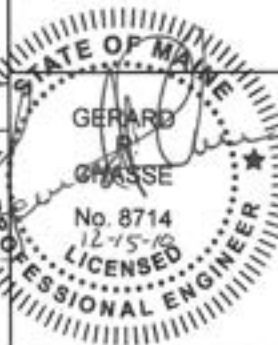

DISTRIBUTION  
CONSTRUCTION  
STANDARDS

RIGID STEEL MAST  
100-400A SERVICE - MULTIPLE METERS  
TO LOW BUILDING

BANGOR HYDRO ELECTRIC Co.

DRAWING  
2703

NO.	REVISION	DATE	CK

NO.	REVISION	DATE	CK

NO.	REVISION	DATE	CK

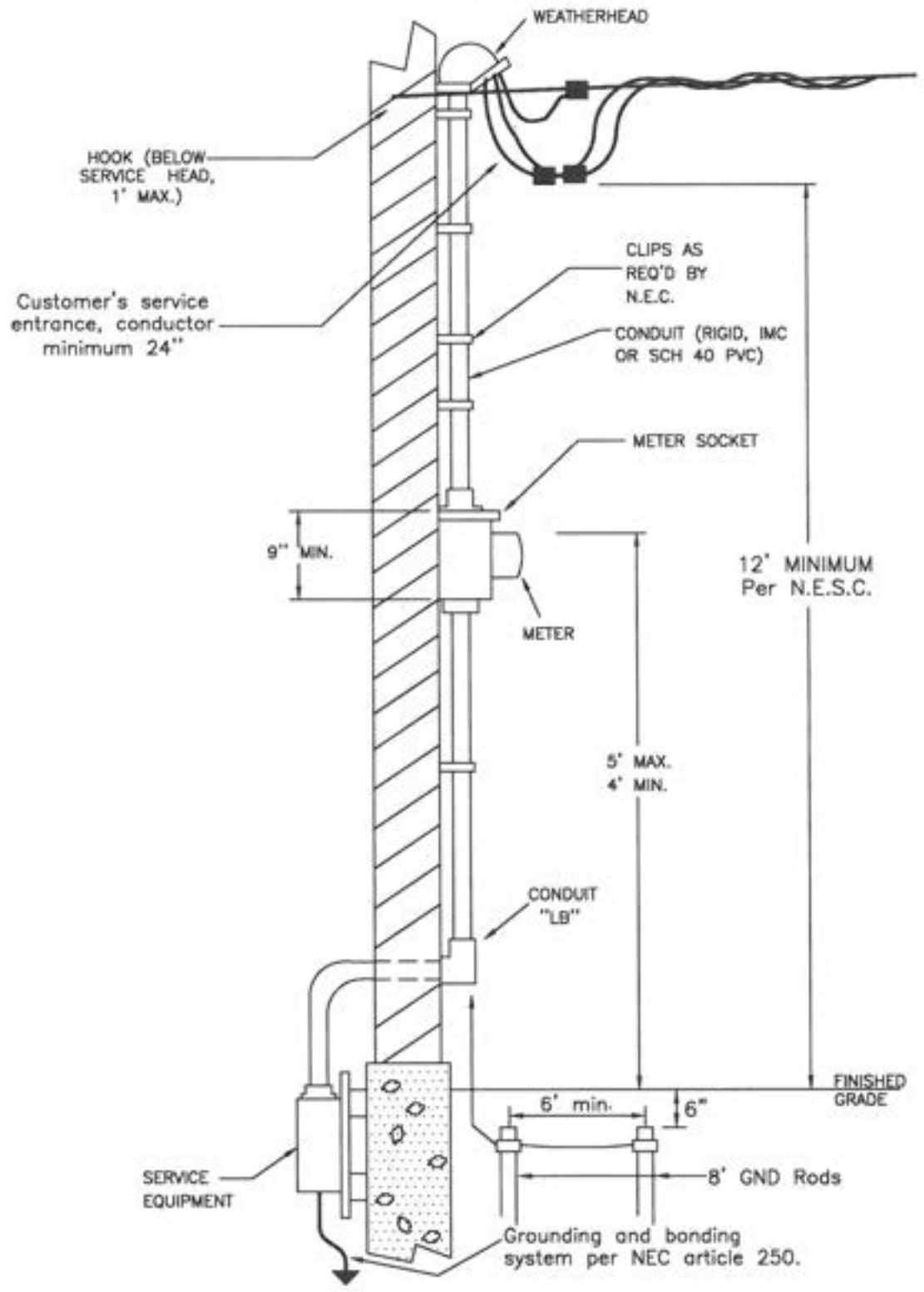

DISTRIBUTION  
CONSTRUCTION  
STANDARDS

OVERHEAD CONDUIT SERVICE  
200 AMPS MAXIMUM

BANGOR HYDRO ELECTRIC Co.

DRAWING  
2704

NO.	REVISION	DATE	CK

NO.	REVISION	DATE	CK

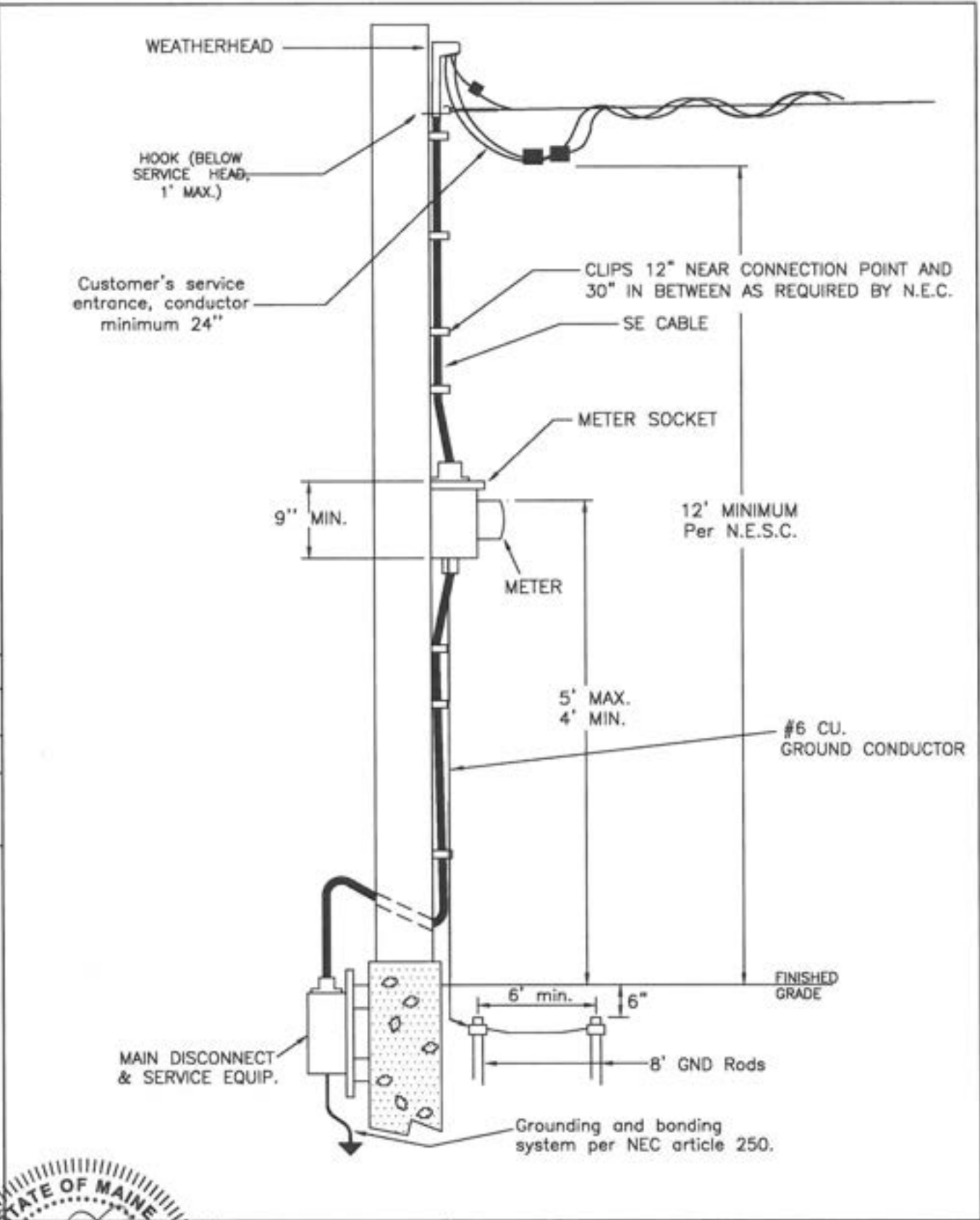

DISTRIBUTION  
CONSTRUCTION  
STANDARDS

OVERHEAD CABLE SERVICE  
400 AMPS MAXIMUM

BANGOR HYDRO ELECTRIC Co.

DRAWING  
2705

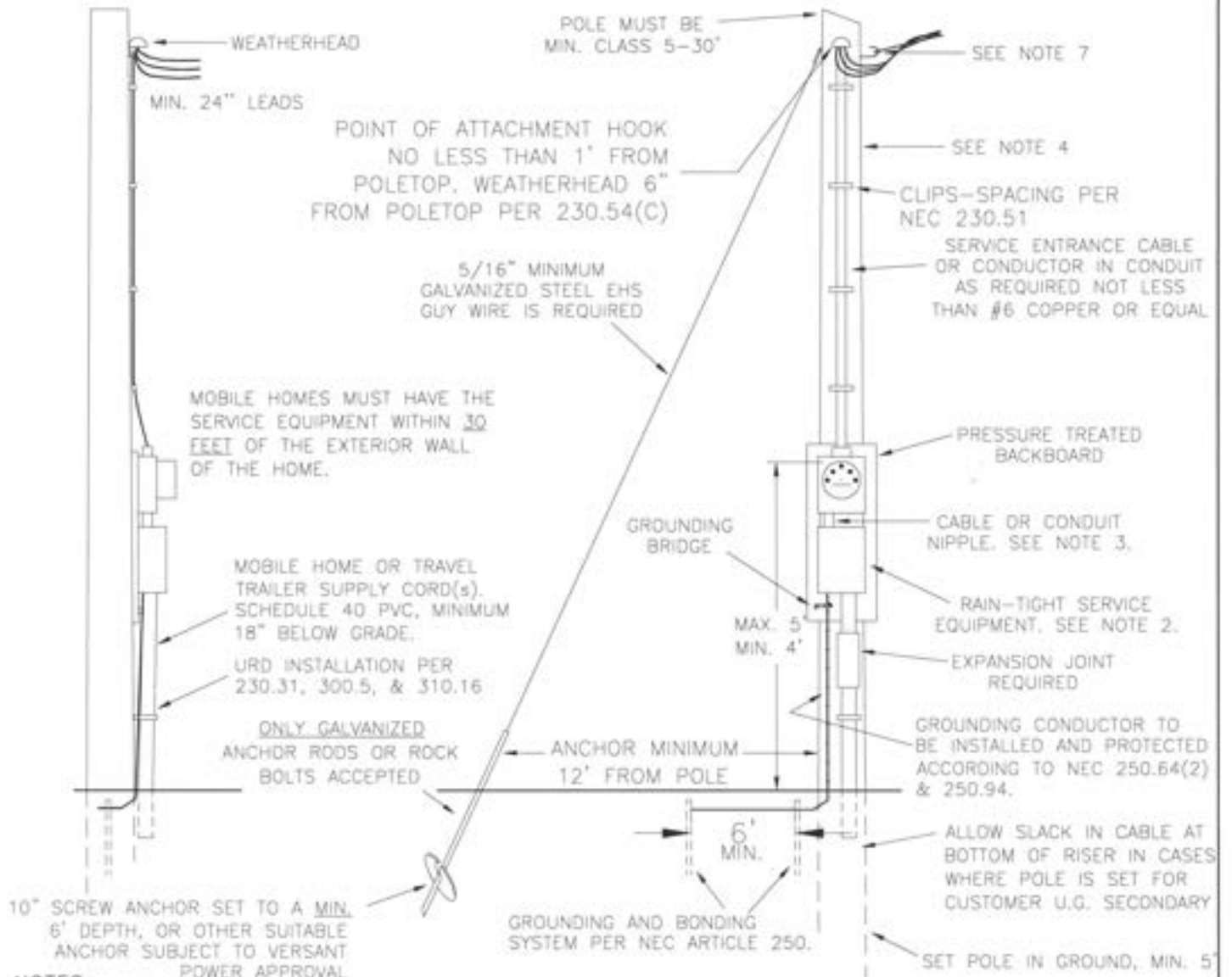

**NOTES:**  
**INSTALLATIONS ON PRIVATELY-OWNED SERVICE POLES**

ALL EQUIPMENT EXCEPT THE SERVICE DROP, SERVICE DROP CONNECTORS AND THE METER ARE TO BE SUPPLIED, INSTALLED AND MAINTAINED BY THE CUSTOMER.

1. THE POLE SHOWN SHOULD BE CONSIDERED AS THE MINIMUM REQUIREMENT. ALL SUCH CUSTOMER OWNED POLES MUST BE OF SUFFICIENT HEIGHT TO ALLOW NECESSARY CLEARANCE FROM GROUND, WITH A MINIMUM 25' POLE ALLOWED. GUYING REQUIREMENTS WILL BE SPECIFIED, ACCORDING TO NEED, BY VERSANT POWER PERSONNEL.
2. RAIN TIGHT SERVICE EQUIPMENT w/ DISCONNECTING MEANS PER 230.70, 230.71, & 230.85 AND OVERCURRENT PROTECTION FOR MOBILE HOME SUPPLY CORDS OR PERMANENTLY INSTALLED CIRCUITS, PER ARTICLE 550 OR 551 OF NEC.
3. IF METALLIC NIPPLE IS USED, IT SHALL BE PROPERLY BONDED PER NEC SECTION 250-72.
4. THE POLE SHALL BE MIN. CLASS 5-30' EASTERN WHITE CEDAR OR PRESSURE TREATED. PRESSURE TREATED POLES MUST BE USED FOR ROAD CROSSINGS AND TRANSFORMER LOCATIONS.
5. THESE INSTALLATIONS ARE ENTIRELY THE PROPERTY AND RESPONSIBILITY OF THE CUSTOMER, HOWEVER THEY MUST MEET VERSANT POWER & NEC REQUIREMENTS.
6. REFER TO VERSANT POWER "REQUIREMENTS AND SPECIFICATIONS FOR ELECTRIC SERVICE INSTALLATIONS" HANDBOOK FOR ADDITIONAL DETAILS.
7. USE OF SLOTTED POINT OF ATTACHMENT IS NOT PERMITTED.



**DISTRIBUTION  
 CONSTRUCTION  
 STANDARDS**



**OVERHEAD SERVICE  
 TO MOBILE HOME OR TRAVEL TRAILER  
 OR CUSTOMER U.G. SECONDARY**

**LAST REVISED**  
 07-10-2020

**DRAWING**  
 2706

## ELEVATION VIEW

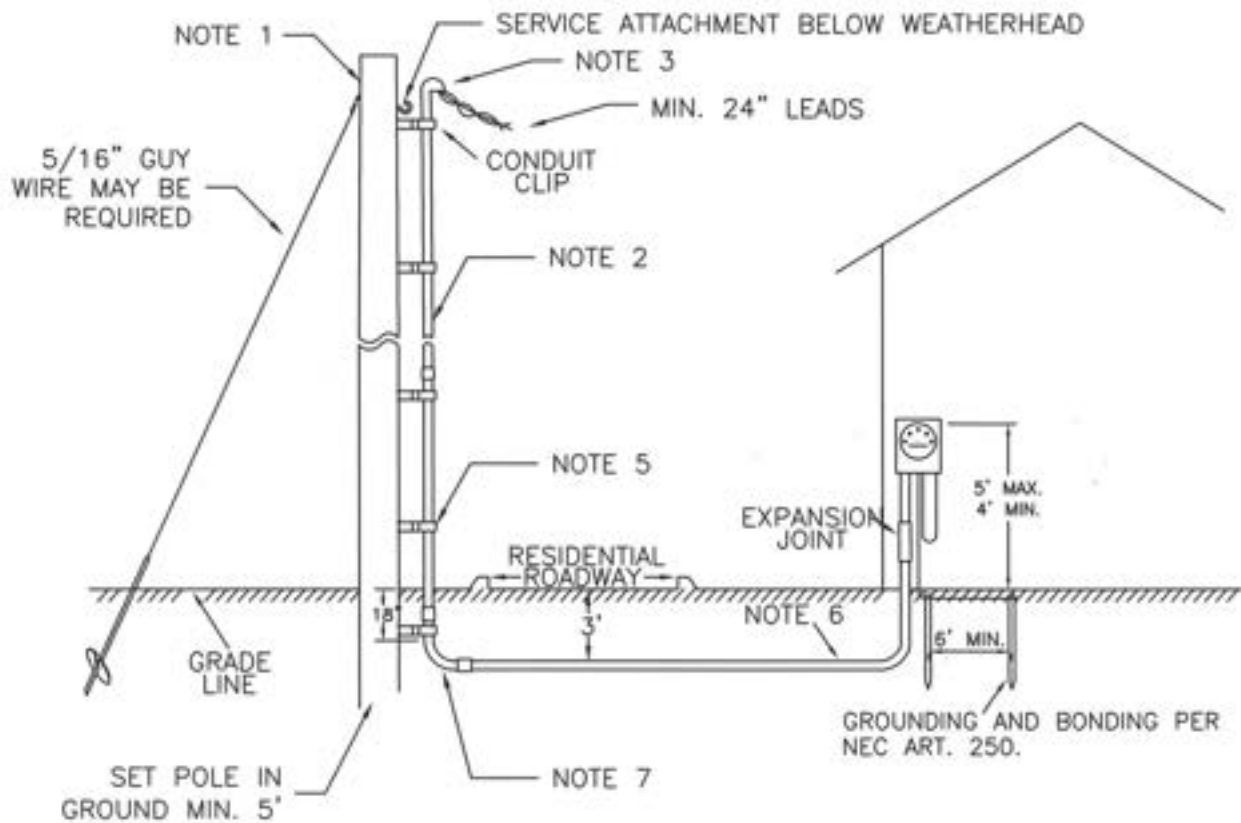

### NOTES:

#### CONDUIT INSTALLATIONS OF CONDUIT ON COMPANY OWNED DISTRIBUTION POLES

1. LOCATION AND HEIGHT OF RISER POLE TO BE SPECIFIED BY VERSANT POWER CONDUIT SHALL NOT BE ATTACHED TO VERSANT POWER POLES WITHOUT THE PRIOR APPROVAL FROM VERSANT POWER.
2. RISERS SHALL BE RIGID METAL. THE MINIMUM CONDUIT SIZE IS 4" FOR ALL THREE PHASE INSTALLATIONS AND 2" FOR SINGLE PHASE INSTALLATIONS.
3. SEAL TOP OF CONDUIT WITH SUITABLE WEATHERHEAD OR CONDULATOR TYPE FITTING. TOP OF CONDUIT MUST EXTEND 4" ABOVE THE NEUTRAL. SLOTTED POINT OF ATTACHMENT IS NOT PERMITTED.
4. CONDUIT GROUNDING CONNECTOR MADE OF EITHER COPPER ALLOY OR GALVANIZED STEEL MATERIAL OF SUITABLE DESIGN. INSTALL POLE GROUND IF ONE DOESN'T EXIST. INSTALL INSULATING GROUNDING BUSHING AT POINT 3 AND GROUND TO SYSTEM NEUTRAL.
5. RISERS MUST USE STANDOFF BRACKETS. INSTALL BRACKETS AT BOTTOM & TOP OF RISER AND EVERY 10' BETWEEN.
6. CABLE RUN SHALL BE IN CONDUIT TO THE METER. SECTION FROM CONDUIT SWEEP TO HOUSE IS CUSTOMER'S RESPONSIBILITY.
7. CONDUIT SWEEP SHALL HAVE A MINIMUM OF A 30" RADIUS BEND AND BE RIGID GALVANIZED STEEL
8. CONDUIT SHALL BE REQUIRED UNDER ALL PAVED AREAS.
9. RIGID NON-METALLIC CONDUIT APPROVED FOR ELECTRIC SERVICE MAY BE USED IN THE BELOW GRADE SECTION(MINIMUM SCHEDULE 40).
10. INSTALLATION OF CONDUIT AND CABLE SHALL BE IN ACCORDANCE WITH THE NATIONAL ELECTRIC CODE.
11. REQUESTS FOR SINGLE PHASE SERVICES RATED IN EXCESS OF 200 AMPERES SHALL BE REFERRED TO T&D ENGINEERING.



**DISTRIBUTION  
CONSTRUCTION  
STANDARDS**



**UNDERGROUND SECONDARY SERVICE  
ON COMPANY OWNED POLES**

LAST REVISED  
07-10-2020

DRAWING  
2707

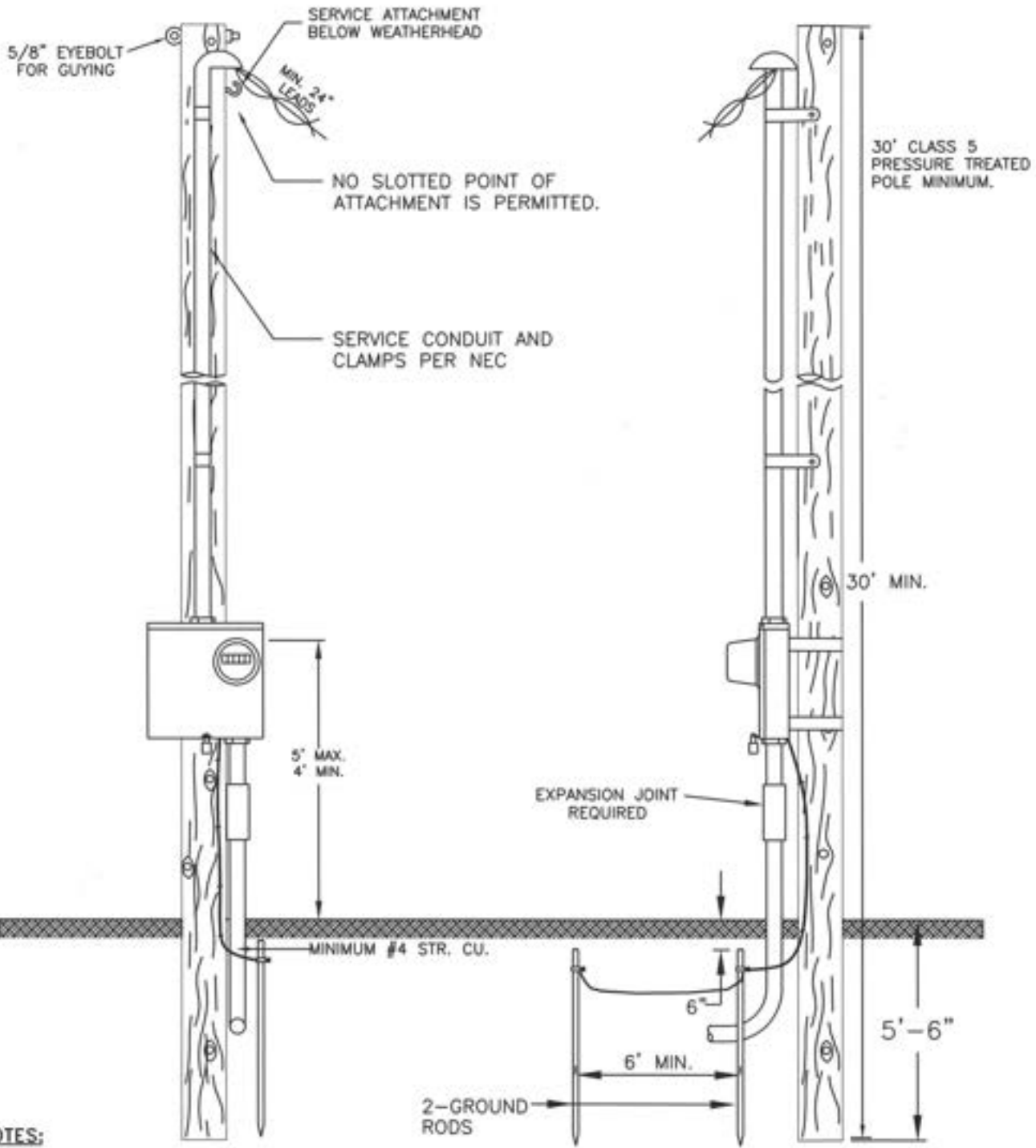

**NOTES:**

1. THIS INSTALLATION IS TO BE USED ONLY WITH PRIOR VERSANT POWER APPROVAL, WITHIN 20' OF A DRIVEABLE AREA, AND ACCESSIBLE BY BUCKET TRUCK.
2. CUSTOMER SHALL PROVIDE POLE IF CONSTRUCTION SPAN LENGTH IS IN EXCESS OF 150'
3. POLE TO BE TAGGED BY VERSANT POWER AND RECORDED IN GIS SYSTEM.
4. GROUNDING & BONDING SYSTEM PER NEC ARTICLE 250.
5. 3/16"x16"x5" ALUMINUM POLE MOUNTING BRACKETS.
6. NO MAIN DISCONNECT AT THE METER IS REQUIRED IF ENTIRE LENGTH OF UNDERGROUND IS IN MINIMUM SCHEDULE 80 PVC CONDUIT.



**DISTRIBUTION  
CONSTRUCTION  
STANDARDS**



**100 - 400AMP METER  
SELF-CONTAINED METER  
PRIVATE POLE MOUNTED**

**REVISED  
07-07-2020**

**DRAWING  
2708**



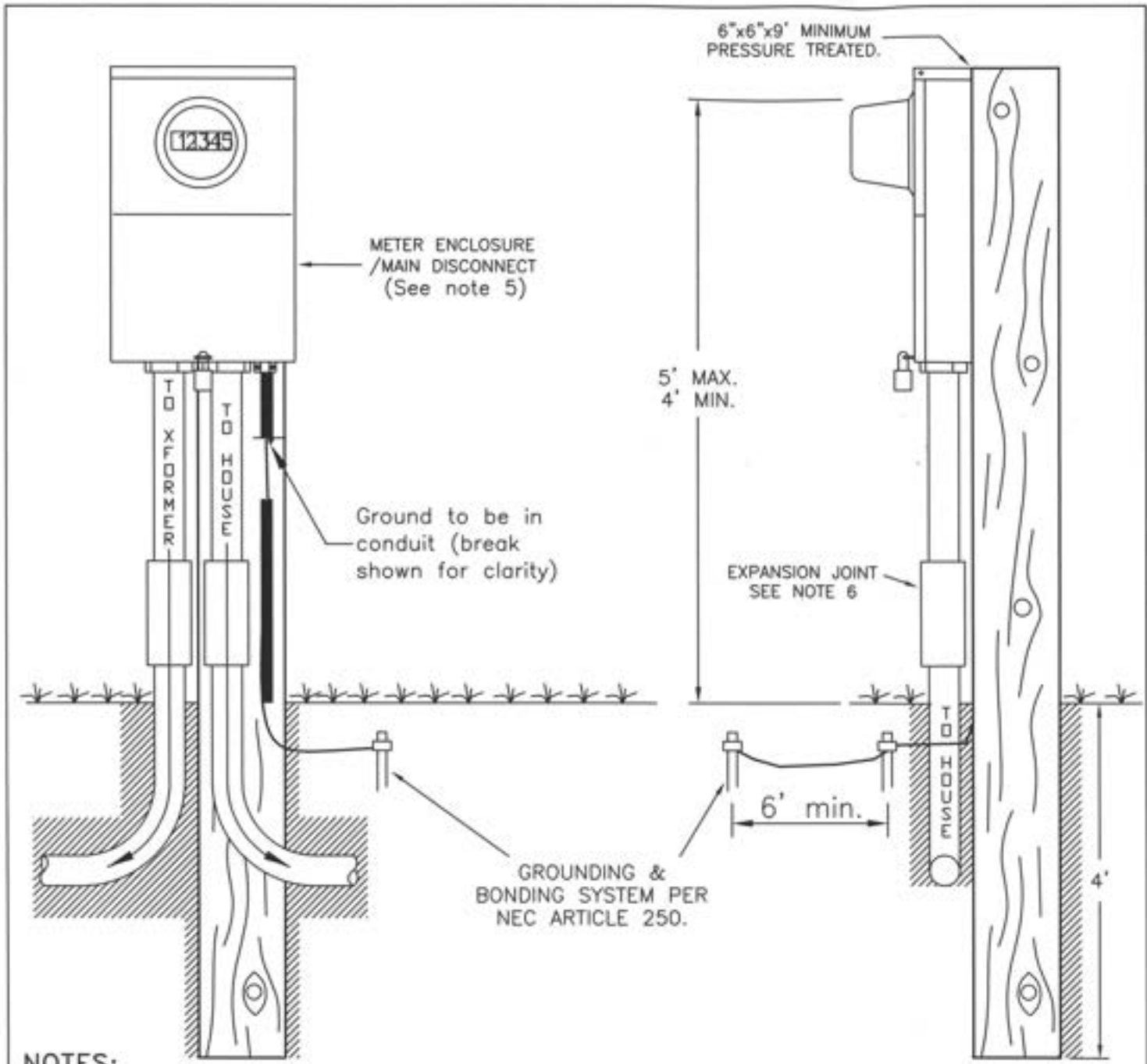

**NOTES:**

1. THE METER ENCLOSURE SHOULD BE APPLICABLE FOR UNDERGROUND APPLICATION.
2. THE TOTAL CABLE RUN FROM THE METER PEDESTAL TO THE TRANSFORMER SHOULD NOT BE MORE THAN 300'. VERSANT POWER WILL NOT GUARANTEE PROPER VOLTAGE OVER 300'.
3. THE PEDESTAL LOCATION MUST BE APPROVED BY VERSANT POWER w/ REGARD TO ACCESSIBILITY.
4. IF THE TOTAL CABLE RUN IS IN CONDUIT (MINIMUM SCHEDULE 40) THE DISCONNECT WILL NOT BE REQUIRED.
5. A COMBINATION METER ENCLOSURE/DISCONNECT IS RECOMMENDED. DISCONNECT PER 230.70, 230.71, & 230.85 REQUIRED.
6. ABOVE GROUND EXPANSION JOINTS REQUIRED.



**DISTRIBUTION  
CONSTRUCTION  
STANDARDS**

  
**VERSANT  
POWER**

<b>100 - 200 AMP OUTDOOR UNDERGROUND METERING PEDESTAL</b>	
<b>LAST REVISED</b> 07-08-2020	<b>DRAWING</b> 2709

NO.	REVISION	DATE	CK

NO.	REVISION	DATE	CK

NO.	REVISION	DATE	CK

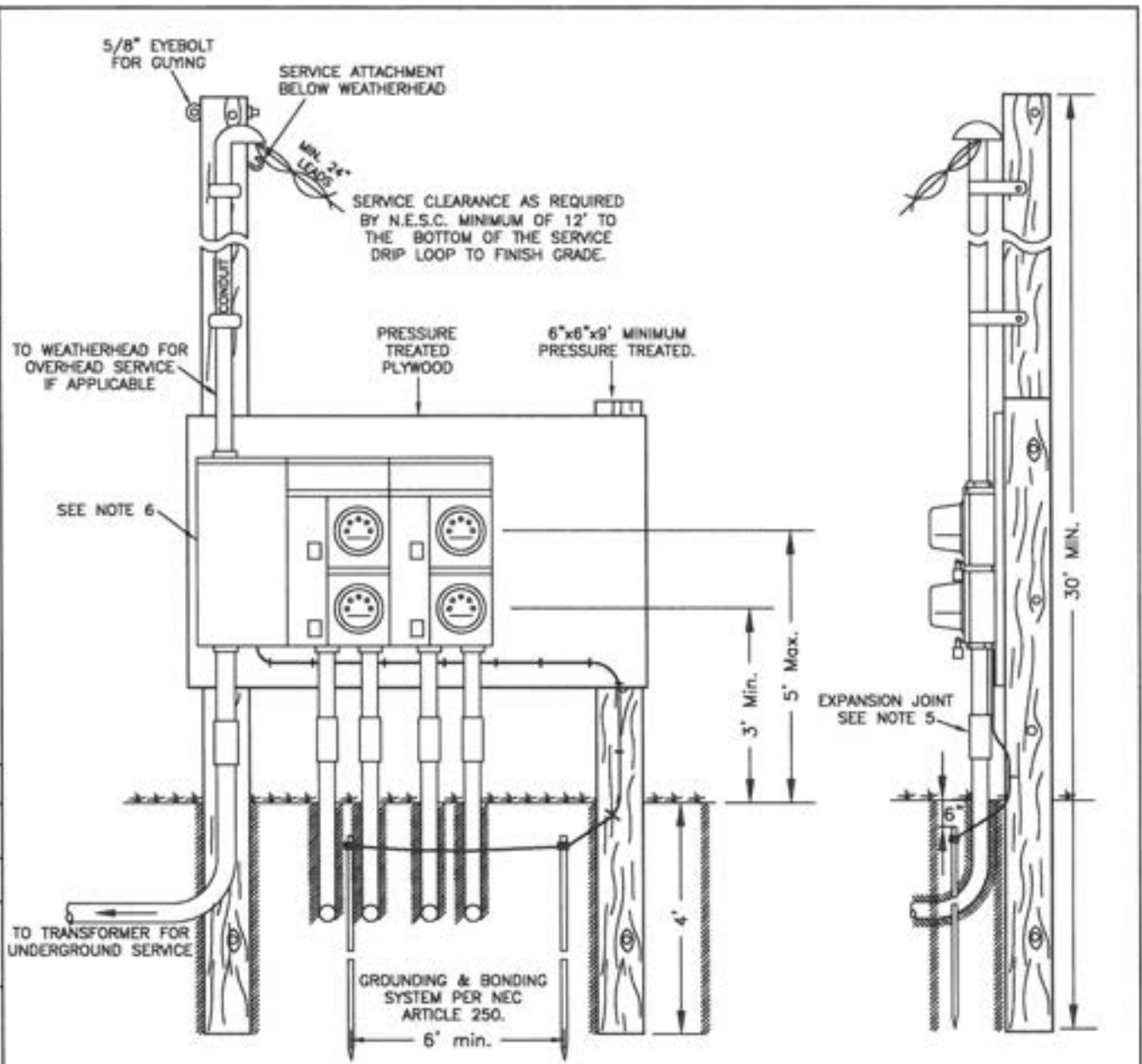

**NOTES:**

1. CONTACT B.H.E. Co. FOR APPROVAL OF THIS SERVICE ARRANGEMENT.
2. THE STRUCTURE MUST BE CONSTRUCTED USING PRESSURE TREATED POLES OR 6"x6" TIMBERS w/ SUFFICIENT STIFFENING ON THE BACKBOARD TO SUPPORT THE EQUIPMENT. PLYWOOD SHOULD BE 3/4" MINIMUM THICKNESS, PRESSURE TREATED & PAINTED.
3. 300' MAXIMUM SECONDARY CABLE RUN.
4. METERS SHALL BE INDIVIDUALLY LABELED w/ WEATHERPROOF LABELS.
5. ABOVE GROUND EXPANSION JOINTS REQUIRED.
6. MAIN SERVICE BREAKER REQUIRED IF MORE THAN 6 METERS ARE INSTALLED.



DISTRIBUTION CONSTRUCTION STANDARDS	MULTI-METERING PEDESTAL STRUCTURE
	BANGOR HYDRO ELECTRIC Co.
DRAWING 2710	

NO.	REVISION	DATE	CK

NO.	REVISION	DATE	CK
	2009 REVISIONS & REFORMAT	3-9-10 (CAN)	

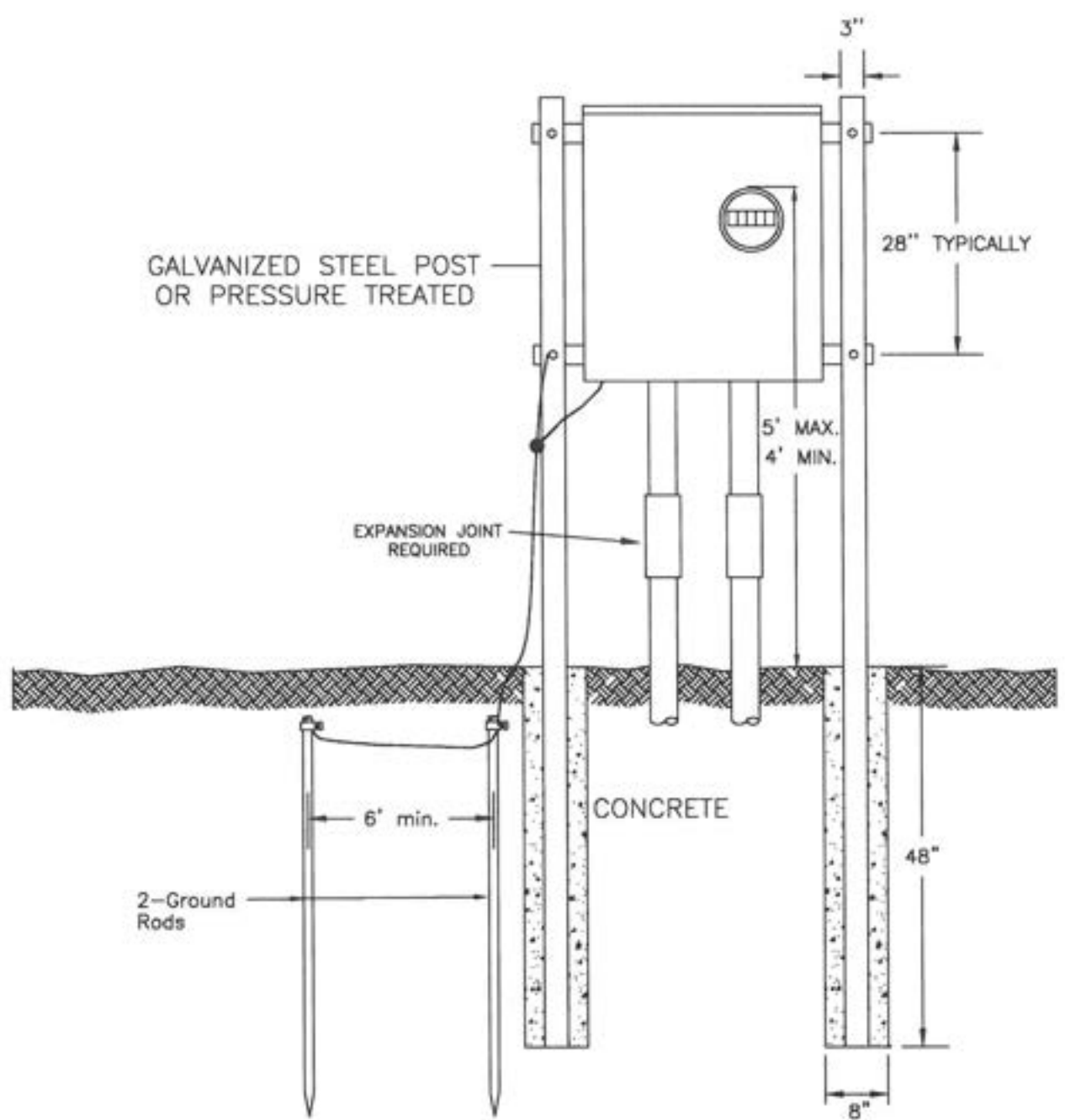

**NOTES:**

1. INSTALLATION IS TO BE USED ONLY WITH PRIOR B.H.E. CO. APPROVAL.
2. THE POSTS SHALL BE 3"x3" GALVANIZED STEEL ANGLE SET IN CONCRETE AS SHOWN.
3. THE HORIZONTAL FRAMING SHALL BE 1-5/8"x2-7/16" 12 GAUGE MINIMUM GALVANIZED STEEL CHANNEL MOUNTED TO THE BACK OF THE POSTS. SHIM AS REQUIRED TO PLUMB ENCLOSURES.
4. GROUNDING AND BONDING SYSTEM PER N.E.C. ARTICLE 250.
5. TWO PRESSURE TREATED (PROOF REQUIRED) 6"x6" TIMBERS SET 4" IN EARTH AND SPANNED BY 3/4" PRESSURE TREATED PLYWOOD OR GALVANIZED CHANNEL CAN BE USED AS AN OPTION. ABOVE GROUND EXPANSION JOINTS REQUIRED. MAIN DISCONNECT IS RECOMMENDED.

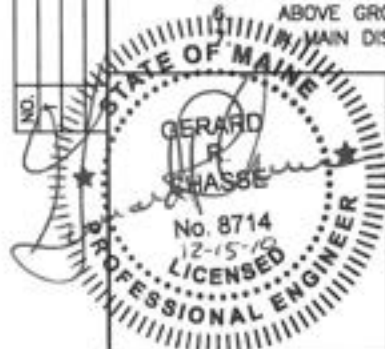

DISTRIBUTION  
CONSTRUCTION  
STANDARDS

200 - 400 AMP  
OUTDOOR UNDERGROUND  
METERING PEDESTAL

BANGOR HYDRO ELECTRIC Co.

DRAWING  
2711

## CLASS 320 METER ENCLOSURE

ALL 120/240 SINGLE PHASE, 120/208 THREE PHASE AND 277/480 THREE PHASE SERVICES GREATER THAN 200 AMPS BUT LESS THAN OR EQUAL TO 400 AMPS WILL BE METERED WITH CLASS 320 ENCLOSURES.

ALL ENCLOSURES WILL HAVE A MECHANICALLY OPERATED LEVER BY-PASS HANDLE. THE ENCLOSURES SHALL BE DESIGNED SO THE COVER CANNOT BE INSTALLED WITH THE BY-PASS ENGAGED.

THE SINGLE PHASE ENCLOSURES SHALL BE A MILBANK U-1797 OR COOPER B-LINE EL32T46GRST OR SIMILAR.

THE THREE PHASE ENCLOSURES SHALL BE A MILBANK U-2120 OR COOPER B-LINE EL32T76GRST OR SIMILAR.

INSTRUMENT TRANSFORMERS WILL BE USED ON 400 AMP 120/240, 120/208Y AND 277/408Y ONLY IN SPECIAL CIRCUMSTANCES WHERE PRIOR APPROVAL IS OBTAINED FROM VERSANT POWER. INSTRUMENT TRANSFORMERS WILL STILL BE USED ON ALL SERVICES OVER 400 AMPS.

	DISTRIBUTION - CONSTRUCTION STANDARDS	CLASS 320 METER ENCLOSURES	
		<u>LAST REVISED</u> 07-14-2020	<u>DRAWING</u> 2712

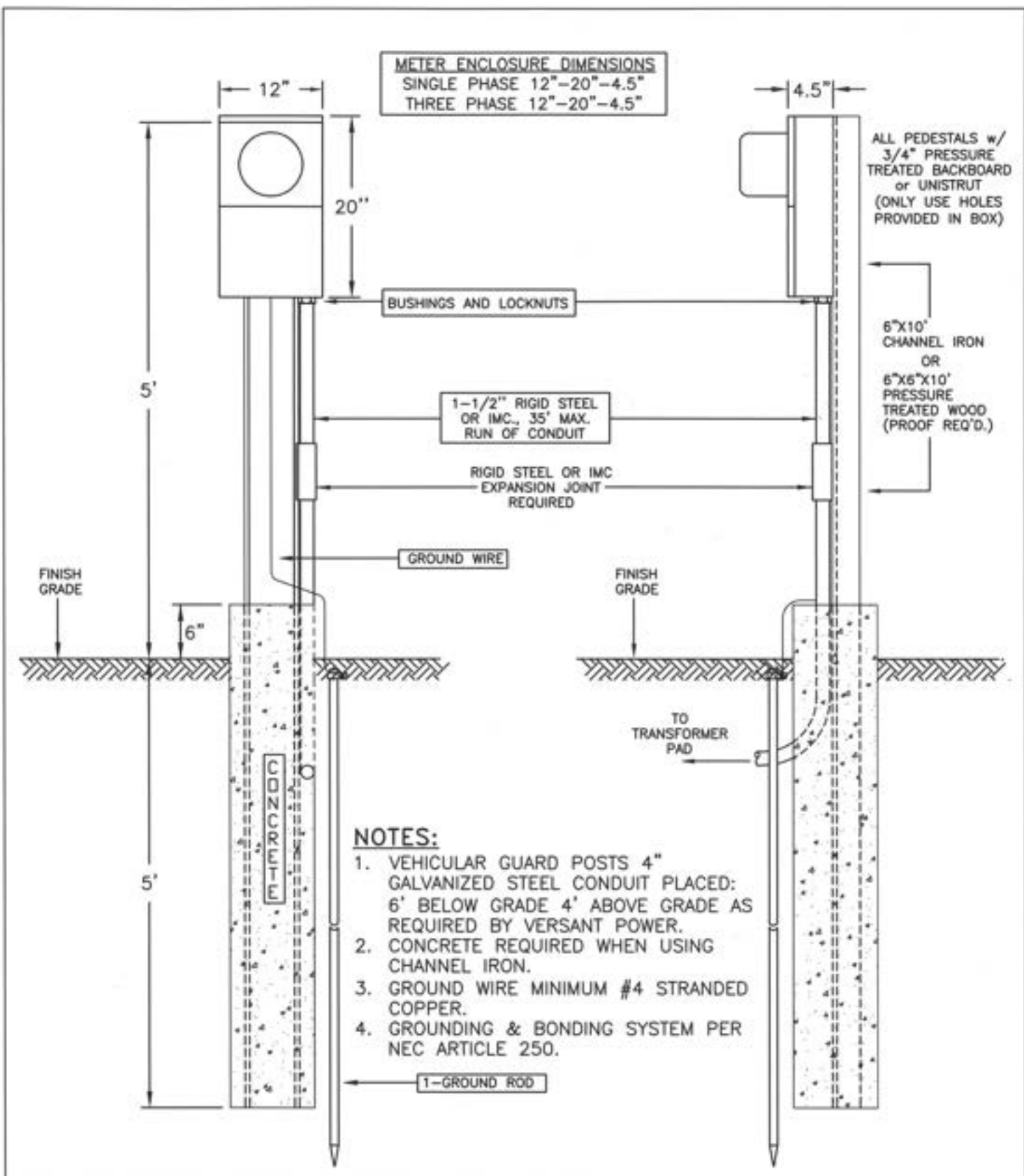

- NOTES:**
1. VEHICULAR GUARD POSTS 4" GALVANIZED STEEL CONDUIT PLACED: 6' BELOW GRADE 4' ABOVE GRADE AS REQUIRED BY VERSANT POWER.
  2. CONCRETE REQUIRED WHEN USING CHANNEL IRON.
  3. GROUND WIRE MINIMUM #4 STRANDED COPPER.
  4. GROUNDING & BONDING SYSTEM PER NEC ARTICLE 250.



**DISTRIBUTION  
CONSTRUCTION  
STANDARDS**

**VERSANT  
POWER**

**OUTDOOR PEDESTAL  
FOR TRANSFORMER RATED  
PAD MOUNTED METERING**

<b>LAST REVISED</b> 07-14-2020	<b>DRAWING</b> 2716
-----------------------------------	------------------------

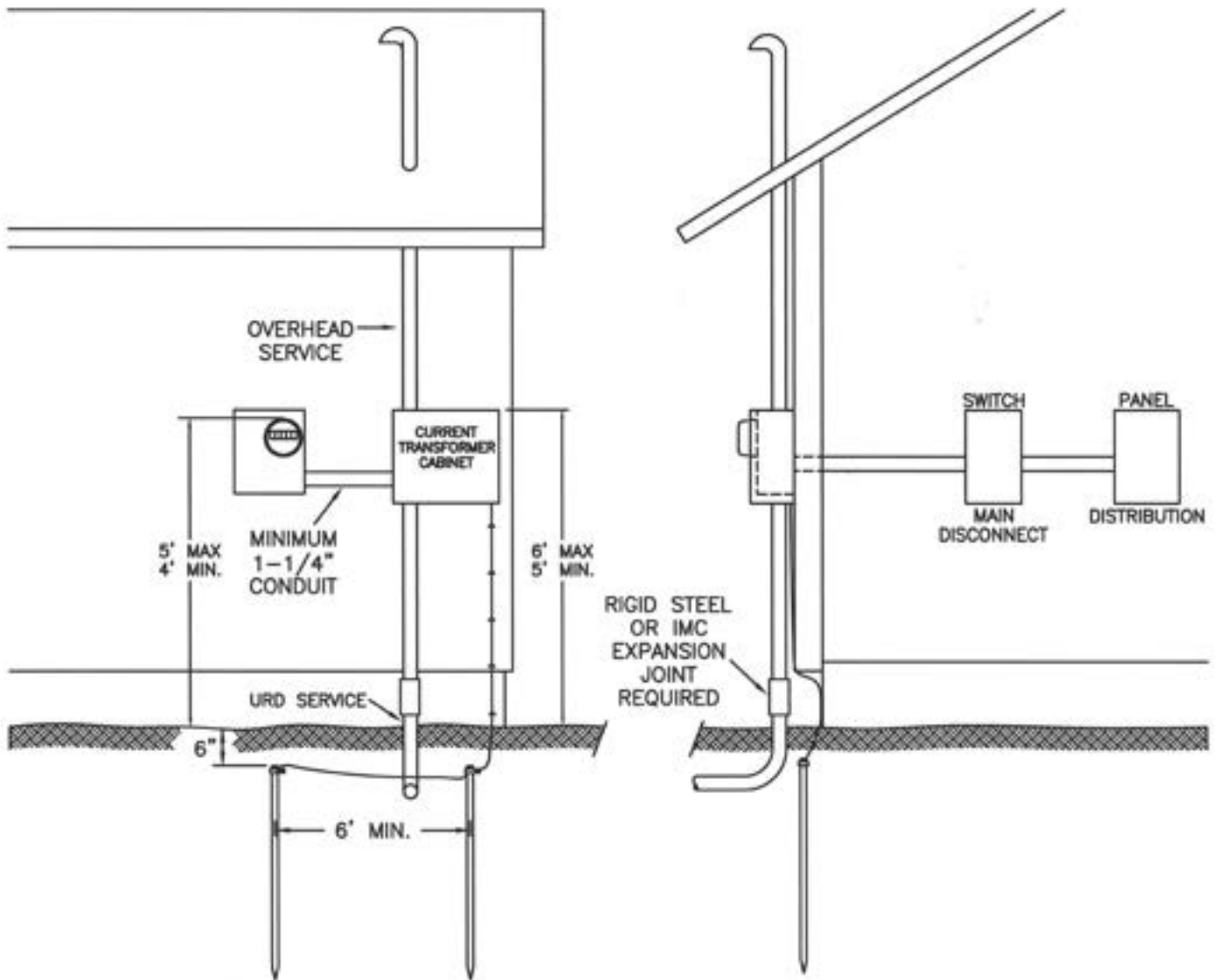

**NOTES:**

1. CURRENT TRANSFORMER CABINET PER REQUIREMENTS OF STANDARD #2713.
2. CURRENT TRANSFORMER CABINET MUST PRECEDE THE MAIN DISCONNECT SWITCH.
3. INSTALLATIONS SHOULD BE APPROVED BY THE METER TECHNICAL DEPARTMENT BEFORE CONSTRUCTION STARTS.
4. GROUNDING AND BONDING SYSTEM PER NEC ARTICLE 250.
5. AN OUTSIDE WEATHERPROOF CURRENT TRANSFORMER CABINET IS REQUIRED.

	<b>DISTRIBUTION CONSTRUCTION STANDARDS</b>	<b>CURRENT TRANSFORMER RATED SERVICE OUTDOOR CT CABINET</b>	
		<b>LAST REVISED</b> 07-14-2020	<b>DRAWING</b> 2718

NO.	REVISION	DATE	CK

NO.	REVISION	DATE	CK
1	2009 REVISIONS & REFORMAT	12-18-09	GAN

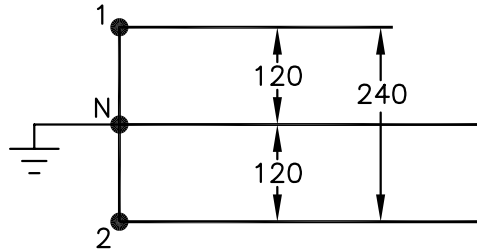
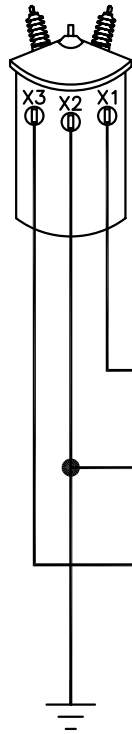

120/240 VOLT ONLY.  
 400 AMP BY-PASS IS REQUIRED.  
 100 AMP, 200 AMP BY-PASS IS  
 ALLOWED IF DISCONNECT IS  
 WITHIN SIGHT OF METER SOCKET.

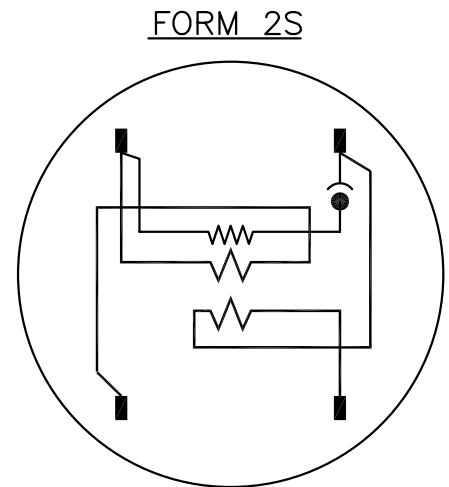
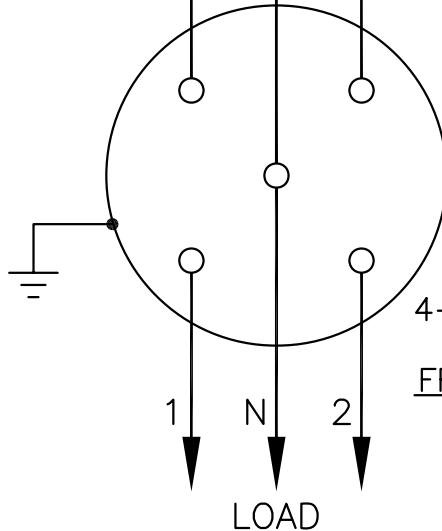

METER  
 INTERNAL DIAGRAM  
 FRONT VIEW

4-TERMINAL  
 SOCKET  
 FRONT VIEW

DISTRIBUTION  
 CONSTRUCTION  
 STANDARDS

METERING STANDARDS  
 FROM A GOUNDED NEUTRAL  
 120/240V THREE WIRE  
 SINGLE PHASE SERVICE

BANGOR HYDRO ELECTRIC Co.

DRAWING  
 2901

NO.	REVISION	DATE	CK

NO.	REVISION	DATE	CK
1	2009 REVISIONS & REFORMAT	12-18-09	GAN

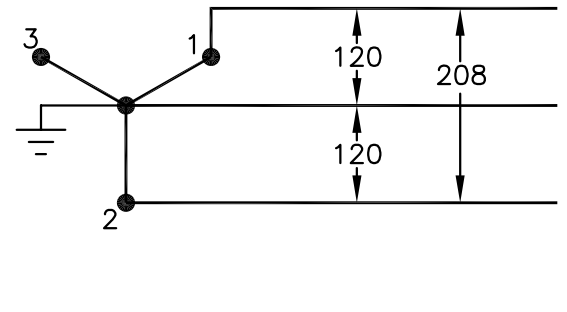
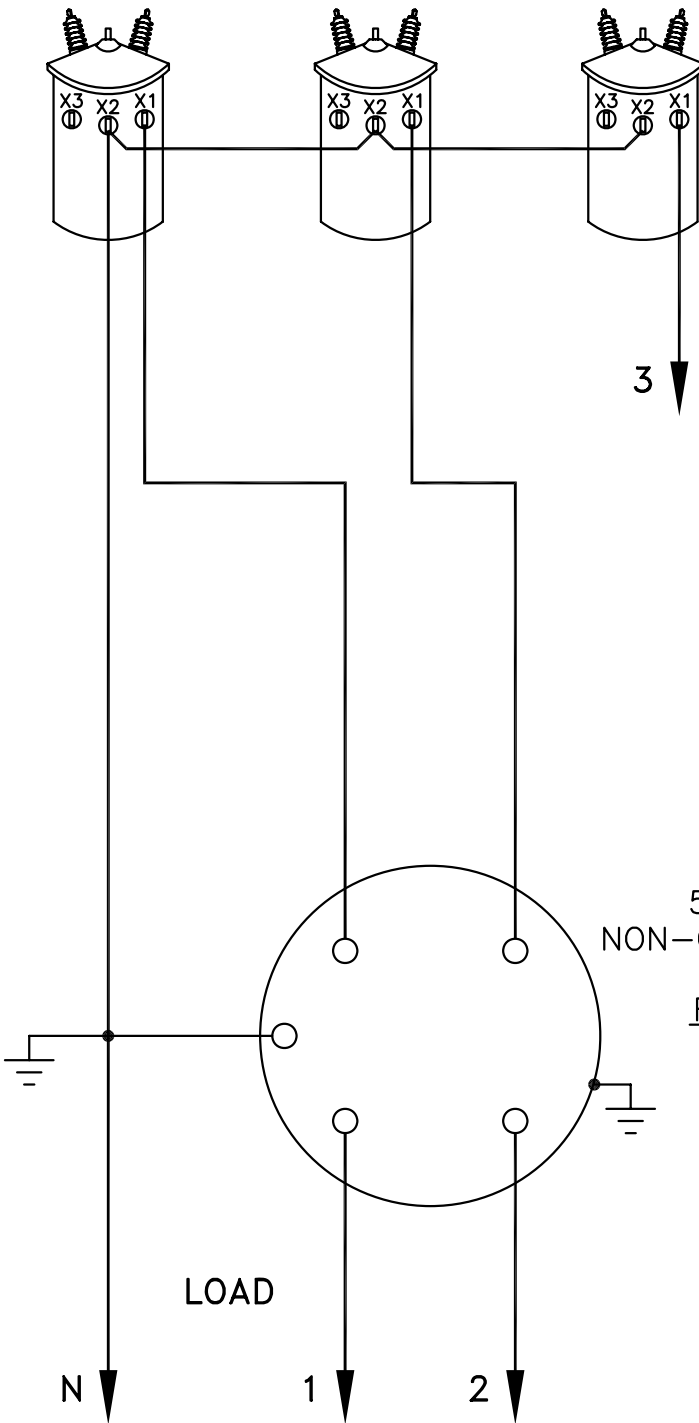

120/208 VOLT ONLY  
100 AMP, 200 AMP  
(NO BY-PASS)

5-TERMINAL  
NON-CIRCUIT CLOSING  
SOCKET  
FRONT VIEW

FORM 12S

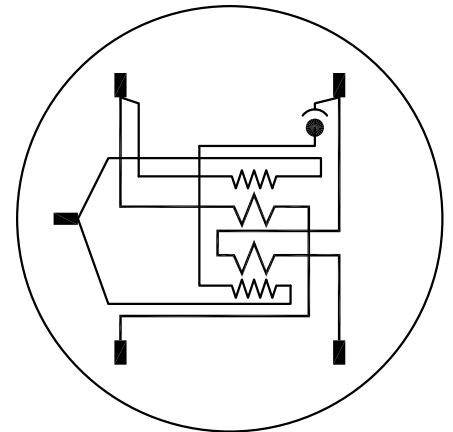

METER  
INTERNAL DIAGRAM  
FRONT VIEW

DISTRIBUTION  
CONSTRUCTION  
STANDARDS

METERING STANDARDS  
ON A NETWORK  
120/208V THREE WIRE SERVICE

BANGOR HYDRO ELECTRIC Co.

DRAWING  
2902



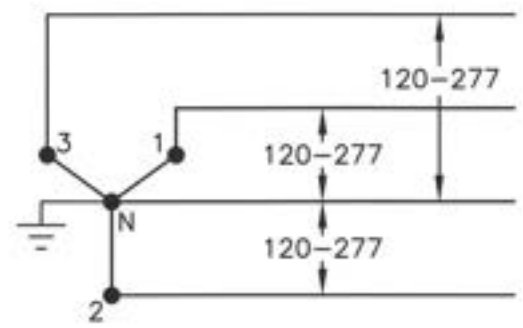
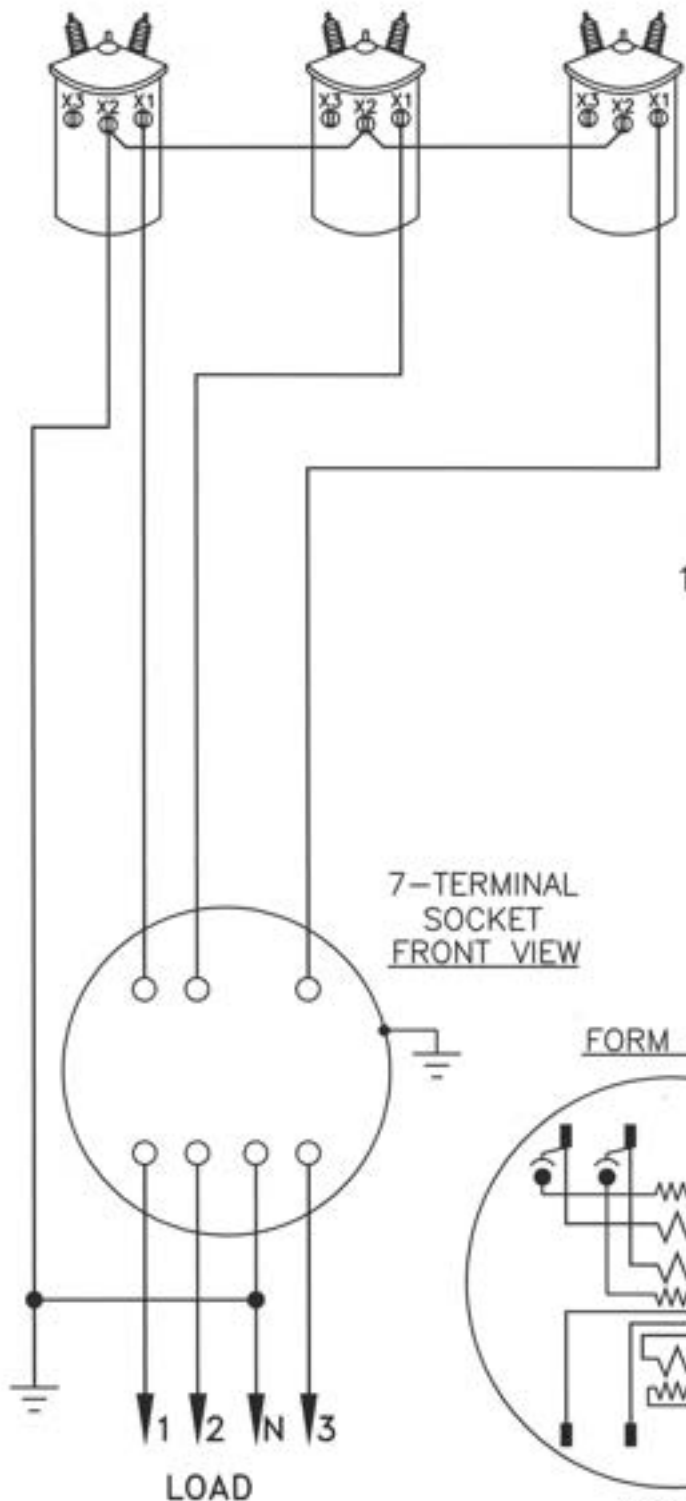

120/208 VOLTS & 277/480 VOLTS  
 100 AMP, 200 AMP, 400 AMP  
 SOCKET METER  
 (BY-PASS REQUIRED)  
 400+ AMP, CT METERING  
 SEE STANDARD #2712  
 FOR APPROVED 400 AMP  
 METER BOXES

7-TERMINAL  
 SOCKET  
 FRONT VIEW

FORM 16S

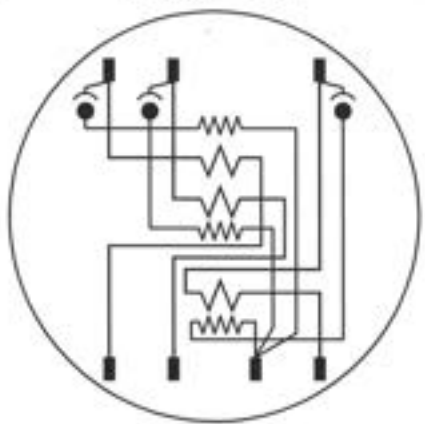

METER  
 INTERNAL DIAGRAM  
 FRONT VIEW



DISTRIBUTION  
 CONSTRUCTION  
 STANDARDS



METERING STANDARDS  
 FOUR WIRE WYE  
 THREE PHASE SERVICE

LAST REVISED  
 07-14-2020

DRAWING  
 2903

NO.	REVISION	DATE	CK

NO.	REVISION	DATE	CK
1	2009 REVISIONS & REFORMAT	12-18-09	GAN

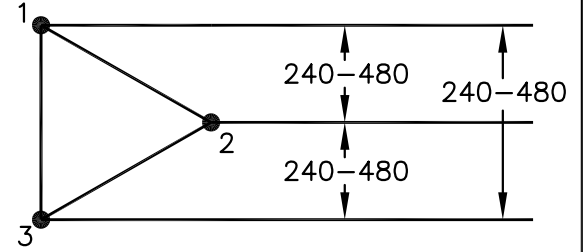
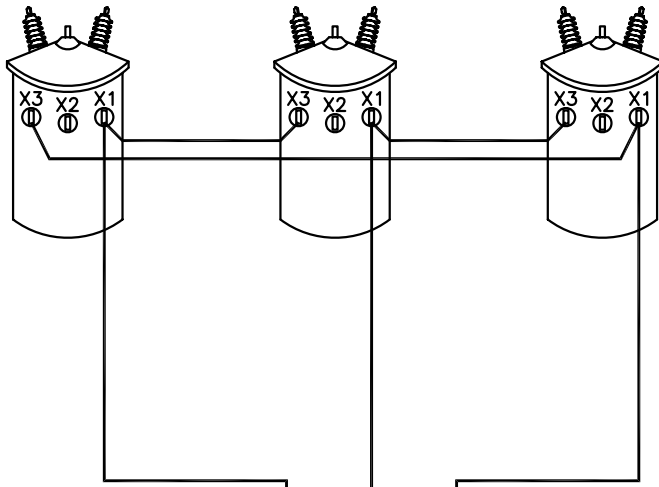

240 VOLT or 480 VOLT ONLY  
 100 AMP, 200 AMP  
 SOCKET METER  
 (BY-PASS REQUIRED)  
 200+ AMP, CT METERING

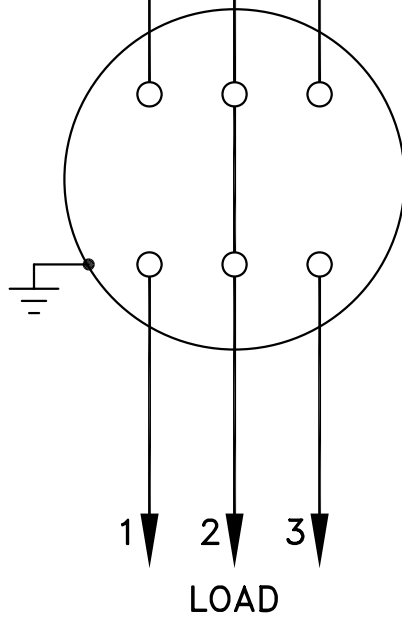

5-JAW  
 6-TERMINAL  
 SOCKET  
 FRONT VIEW

FORM 12S

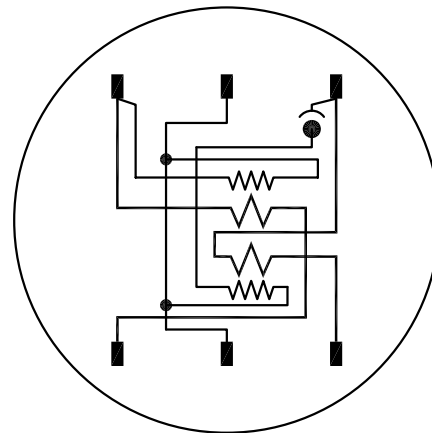

METER  
 INTERNAL DIAGRAM  
 FRONT VIEW

DISTRIBUTION  
 CONSTRUCTION  
 STANDARDS

METERING STANDARDS  
 THREE WIRE DELTA  
 THREE PHASE SERVICE

BANGOR HYDRO ELECTRIC Co.

DRAWING  
 2904